

SIP Strobe

Operations Guide

Part #011087
Document Part #930425C
for Firmware Version 1.0.1

CyberData Corporation
3 Justin Court
Monterey, CA 93940
(831) 373-2601

SIP Strobe Operations Guide 930425C
Part # 011087

COPYRIGHT NOTICE:

© 2011, CyberData Corporation, ALL RIGHTS RESERVED.

This manual and related materials are the copyrighted property of CyberData Corporation. No part of this manual or related materials may be reproduced or transmitted, in any form or by any means (except for internal use by licensed customers), without prior express written permission of CyberData Corporation. This manual, and the products, software, firmware, and/or hardware described in this manual are the property of CyberData Corporation, provided under the terms of an agreement between CyberData Corporation and recipient of this manual, and their use is subject to that agreement and its terms.

DISCLAIMER: Except as expressly and specifically stated in a written agreement executed by CyberData Corporation, CyberData Corporation makes no representation or warranty, express or implied, including any warranty or merchantability or fitness for any purpose, with respect to this manual or the products, software, firmware, and/or hardware described herein, and CyberData Corporation assumes no liability for damages or claims resulting from any use of this manual or such products, software, firmware, and/or hardware. CyberData Corporation reserves the right to make changes, without notice, to this manual and to any such product, software, firmware, and/or hardware.

OPEN SOURCE STATEMENT: Certain software components included in CyberData products are subject to the GNU General Public License (GPL) and Lesser GNU General Public License (LGPL) "open source" or "free software" licenses. Some of this Open Source Software may be owned by third parties. Open Source Software is not subject to the terms and conditions of the CyberData COPYRIGHT NOTICE or software licenses. Your right to copy, modify, and distribute any Open Source Software is determined by the terms of the GPL, LGPL, or third party, according to who licenses that software.

Software or firmware developed by CyberData that is unrelated to Open Source Software is copyrighted by CyberData, subject to the terms of CyberData licenses, and may not be copied, modified, reverse-engineered, or otherwise altered without explicit written permission from CyberData Corporation.

TRADEMARK NOTICE: CyberData Corporation and the CyberData Corporation logos are trademarks of CyberData Corporation. Other product names, trademarks, and service marks may be the trademarks or registered trademarks of their respective owners.



Technical Support

The fastest way to get technical support for your VoIP product is to submit a VoIP Technical Support form at the following website:
<http://www.cyberdata.net/support/contactsupportvoip.html>

We have several technical support staff monitoring this form and they will contact you within 12 hours after receiving a submission.

Phone: (831) 373-2601, Ext. 333



Email: support@cyberdata.net

Fax: (831) 373-4193



Company and product information is at www.cyberdata.net.

Important Safety Instructions

1. Read these instructions.
2. Keep these instructions.
3. Heed all warnings.
4. Follow all instructions.
5. Do not use this apparatus near water.
6. Clean only with dry cloth.
7. Do not block any ventilation openings. Install in accordance with the manufacturer's instructions.
8. Do not install near any heat sources such as radiators, heat registers, stoves, or other apparatus (including amplifiers) that produce heat.
9. Do not defeat the safety purpose of the polarized or grounding-type plug. A polarized plug has two blades with one wider than the other. A grounding type plug has two blades and a third grounding prong. The wide blade or the third prong are provided for your safety. If the provided plug does not fit into your outlet, consult an electrician for replacement of the obsolete outlet.
10. Protect the power cord from being walked on or pinched particularly at plugs, convenience receptacles, and the point where they exit from the apparatus.
11. Only use attachments/accessories specified by the manufacturer.
12. Refer all servicing to qualified service personnel. Servicing is required when the apparatus has been damaged in any way, such as power-supply cord or plug is damaged, liquid has been spilled or objects have fallen into the apparatus, the apparatus has been exposed to rain or moisture, does not operate normally, or has been dropped.
13. Prior to installation, consult local building and electrical code requirements.
- 14. WARNING: The SIP Strobe enclosure is not rated for any AC voltages!**

 <p>GENERAL ALERT</p>	<p>Warning</p> <p><i>Electrical Hazard:</i> This product should be installed by a licensed electrician according to all local electrical and building codes.</p>
 <p>GENERAL ALERT</p>	<p>Warning</p> <p><i>Electrical Hazard:</i> To prevent injury, this apparatus must be securely attached to the floor/wall in accordance with the installation instructions.</p>

Pictorial Alert Icons

	<p>General Alert</p> <p><i>This pictorial alert indicates a potentially hazardous situation. This alert will be followed by a hazard level heading and more specific information about the hazard.</i></p>
	<p>Ground</p> <p><i>This pictorial alert indicates the Earth grounding connection point.</i></p>

Hazard Levels

Danger: Indicates an imminently hazardous situation which, if not avoided, will result in death or serious injury. This is limited to the most extreme situations.

Warning: Indicates a potentially hazardous situation which, if not avoided, could result in death or serious injury.

Caution: Indicates a potentially hazardous situation which, if not avoided, could result in minor or moderate injury. It may also alert users against unsafe practices.

Notice: Indicates a statement of company policy (that is, a safety policy or protection of property).

The safety guidelines for the equipment in this manual do not purport to address all the safety issues of the equipment. It is the responsibility of the user to establish appropriate safety, ergonomic, and health practices and determine the applicability of regulatory limitations prior to use. Potential safety hazards are identified in this manual through the use of words **Danger**, **Warning**, and **Caution**, the specific hazard type, and pictorial alert icons.

Abbreviations and Terms

Abbreviation or Term	Definition
A-law	A standard companding algorithm, used in European digital communications systems to optimize, i.e., modify, the dynamic range of an analog signal for digitizing.
AVP	Audio Video Profile
Cat 5	TIA/EIA-568-B Category 5
DHCP	Dynamic Host Configuration Protocol
LAN	Local Area Network
LED	Light Emitting Diode
Mbps	Megabits per Second.
NTP	Network Time Protocol
PBX	Private Branch Exchange
PoE	Power over Ethernet (as per IEEE 802.3af standard)
RTFM	Reset Test Function Management
SIP	Session Initiated Protocol
u-law	A companding algorithm, primarily used in the digital telecommunication
UC	Unified Communications
VoIP	Voice over Internet Protocol

Revision Information

Revision 930425C, which corresponds to firmware version 1.0.1, was released on December 9, 2011 and has the following changes:

- Updates [Figure 2-1, "SIP Strobe Connections"](#).
- Updates [Figure 2-2, "Auxiliary Relay Wiring Diagram"](#).
- Updates [Figure 2-3, "Connector Locations"](#).
- Updates [Figure 2-4, "Connector Locations"](#).

Contents

Chapter 1 Product Overview	1
1.1 How to Identify This Product	1
1.2 Typical System Installation	2
1.3 Product Features	3
1.4 Supported Protocols	3
1.5 Supported SIP Servers	3
1.6 Product Specifications	4
1.7 Dimensions	4
Chapter 2 Installing the SIP Strobe	5
2.1 Parts List	5
2.1 SIP Strobe Setup	6
2.1.1 SIP Strobe Connections	6
2.1.2 Connecting a Device to the Auxiliary Relay	7
2.1.3 Identifying the SIP Strobe Connectors and Jumpers	8
2.1.4 Network Connectivity, and Data Rate	10
2.1.5 RTFM Switch	12
2.1.6 Restore the Factory Default Settings	13
2.2.1 SIP Strobe Web Page Navigation	15
2.2.2 Log in to the Configuration Home Page	16
2.2.3 Configure the Device	19
2.2.4 Configure the Network Parameters	21
2.2.5 Configure the SIP Parameters	23
2.2.6 Configure the Night Ringer Parameters	25
2.2.7 Configure the Sensor Configuration Parameters	27
2.2.8 Configure the Event Parameters	29
2.2.9 Configure the Autoprovisioning Parameters	34
2.3.1 Reboot the SIP Strobe	40
Appendix A Mounting the SIP Strobe	41
A.1 Mount the SIP Strobe	41
Appendix B Troubleshooting/Technical Support	45
B.1 Frequently Asked Questions (FAQ)	45
B.2 Documentation	45
B.3 Contact Information	46
B.4 Warranty	47
B.4.1 Warranty & RMA Returns within the United States	47
B.4.2 Warranty & RMA Returns Outside of the United States	47
B.4.3 Spare in the Air Policy	47
B.4.4 Return and Restocking Policy	48
B.4.5 Warranty and RMA Returns Page	48
Index	49

1 Product Overview

1.1 How to Identify This Product

To identify the SIP Strobe, look for a model number label similar to the one shown in [Figure 1-1](#). The model number on the label should be 011087.

Figure 1-1. Model Number Label

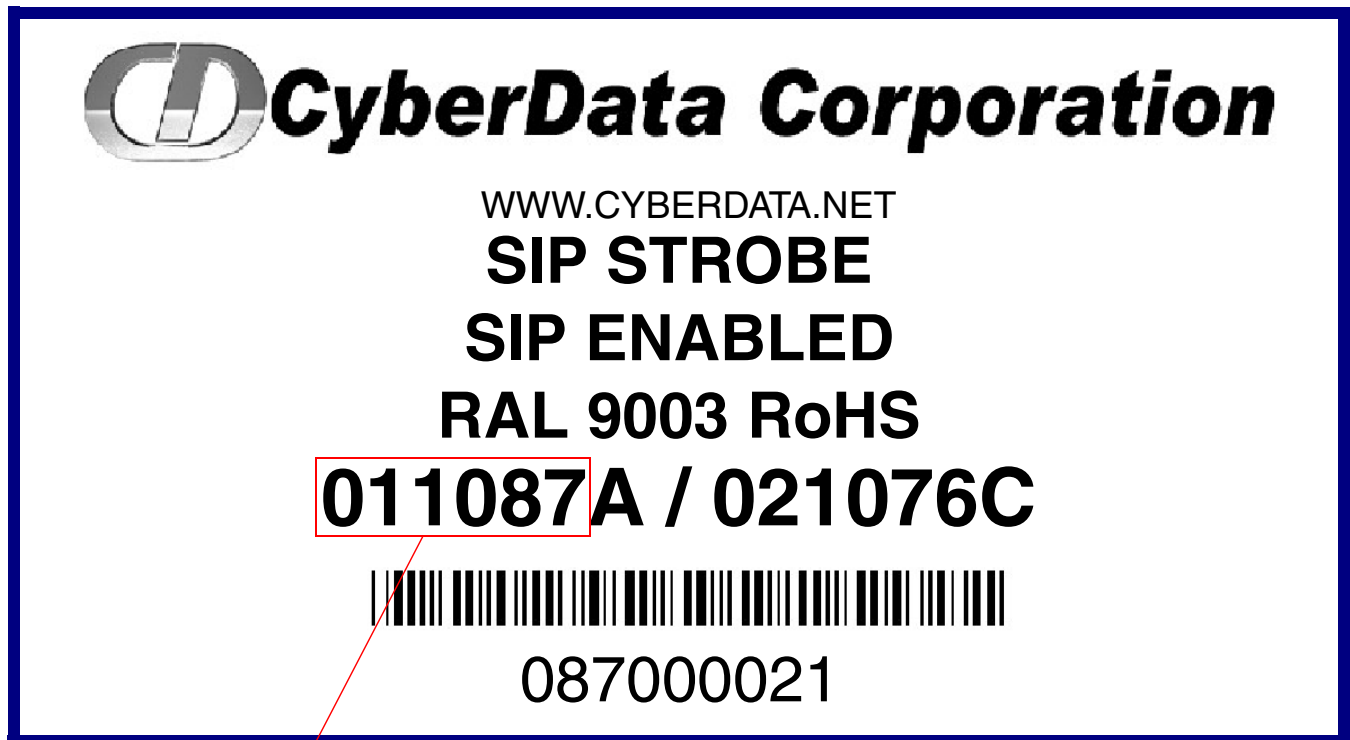

Model number



1.2 Typical System Installation

The Session Initiation Protocol (SIP) SIP Strobe is a SIP endpoint designed to provide VoIP phone connectivity in a tamper proof and secure package.

Figure 1-2 illustrate how the SIP Strobes can be installed as part of a VoIP phone system.

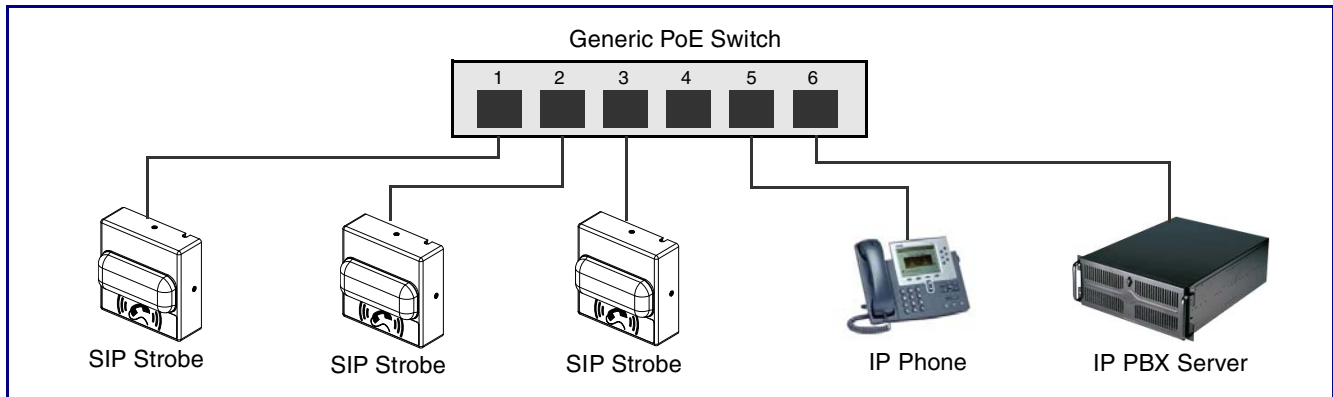
Figure 1-2. Typical Installation



 GENERAL ALERT	<p>Warning <i>Electrical Hazard:</i> The SIP Strobe enclosure is not rated for any AC voltages.</p>
 GENERAL ALERT	<p>Warning <i>Electrical Hazard:</i> This product should be installed by a licensed electrician according to all local electrical and building codes.</p>
 GENERAL ALERT	<p>Warning <i>Electrical Hazard:</i> To prevent injury, this apparatus must be securely attached to the floor/wall in accordance with the installation instructions.</p>

1.3 Product Features

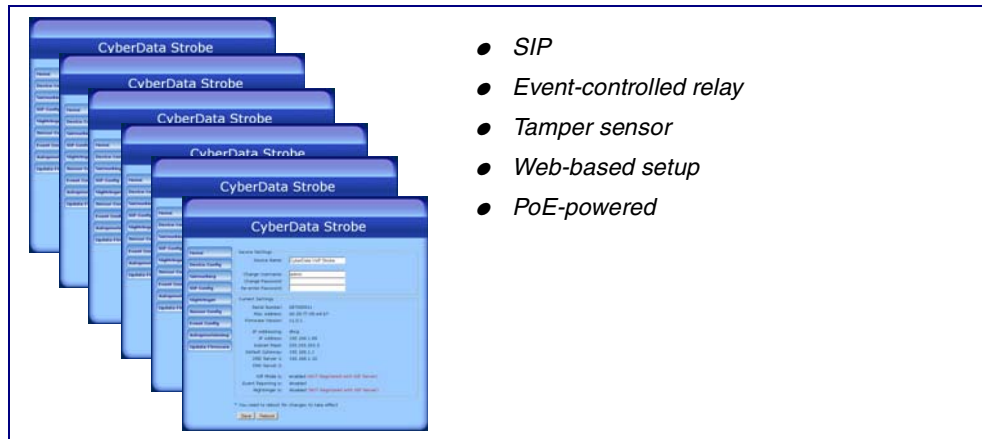

1.4 Supported Protocols

The SIP Strobe supports:

- SIP
- HTTP Web-based configuration

Provides an intuitive user interface for easy system configuration and verification of SIP Strobe operations.

- DHCP Client

Dynamically assigns IP addresses in addition to the option to use static addressing.

- RTP
- RTP/AVP - Audio Video Profile
- Audio Encodings

PCMU (G.711 mu-law)

PCMA (G.711 A-law)

Packet Time 20 ms

1.5 Supported SIP Servers

Go to the following link to find the SIP Strobe product page which will have information on how to configure the SIP Strobe for various supported SIP servers:

<http://www.cyberdata.net/support/server/index.html>

1.6 Product Specifications

Category	Specification
Network Rate	10/100 Mbps
Power Requirement	802.3af compliant or 10 to 20 VDC at 1000 mA
Protocol	SIP
Part Number	011087
Dimensions	4.5" x 4.5" x 1.5"
Weight	1.6 lbs./shipping weight of 2.2 lbs. (0.7 kg/shipping weight of 1.0kg)
Auxiliary Relay	1A at 30 VDC

1.7 Dimensions

Figure 1-3. Dimensions—Size of Unit with Case

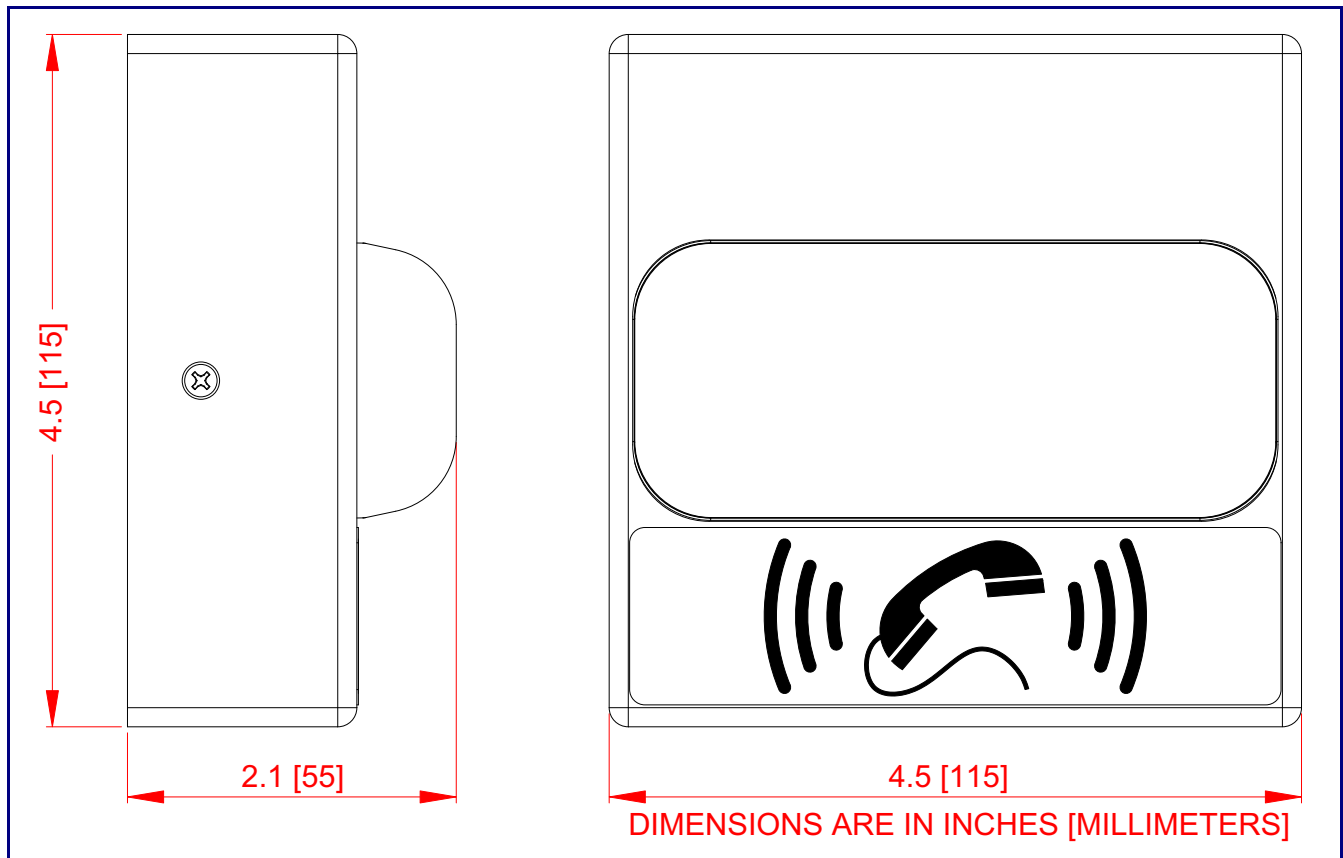



2 Installing the SIP Strobe

2.1 Parts List

Table 2-1 illustrates the SIP Strobe parts.

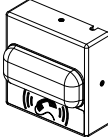
Table 2-1. Parts List

Quantity	Part Name	Illustration
1	SIP Strobe Assembly	
1	Installation Quick Reference Guide	
1	SIP Strobe Mounting Accessory Kit	

2.1 SIP Strobe Setup

2.1.1 SIP Strobe Connections

Figure 2-1 shows the pin connections on the J7 (terminal block). This terminal block can accept 16 AWG gauge wire.

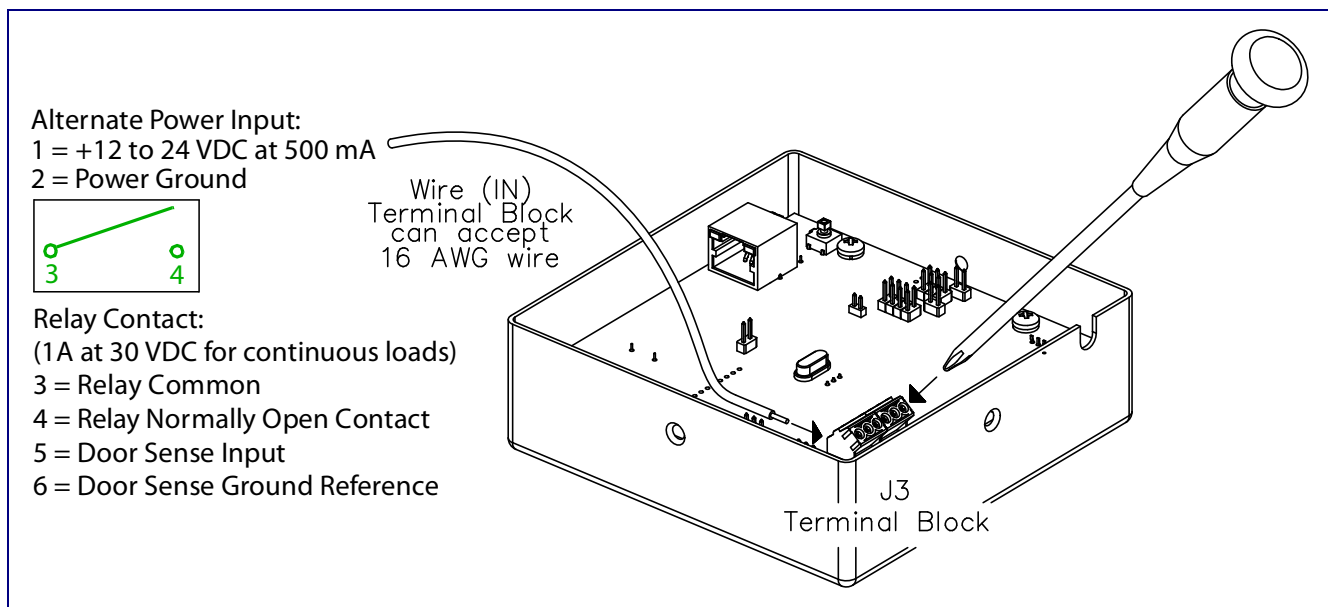

Note As an alternative to using PoE power, you can supply 12 to 24 VDC at 500 mA into the terminal block.

Figure 2-1. SIP Strobe Connections



2.1.2 Connecting a Device to the Auxiliary Relay

The SIP Strobe incorporates an on-board relay which enables users to control an external relay for activating an auxiliary device such as an electric door strike (see [Figure 2-2](#)). The SIP Strobe relay contacts are limited to 1 amp at 30VDC. The SIP Strobe relay activation time is selectable through the web interface and is controlled by DTMF tones generated from the phone being called. The DTMF tones are selectable from the web interface as well.

 <p>GENERAL ALERT</p>	<p>Warning <i>Electrical Hazard:</i> The SIP Strobe enclosure is not rated for any AC voltages.</p>
 <p>GENERAL ALERT</p>	<p>Warning <i>Electrical Hazard:</i> This product should be installed by a licensed electrician according to all local electrical and building codes.</p>
 <p>GENERAL ALERT</p>	<p>Warning <i>Electrical Hazard:</i> To prevent injury, this apparatus must be securely attached to the floor/wall in accordance with the installation instructions.</p>

Note The three digit code for the auxiliary relay must be sent in conformance with RFC2833 DTMF generation.

Figure 2-2. Auxiliary Relay Wiring Diagram

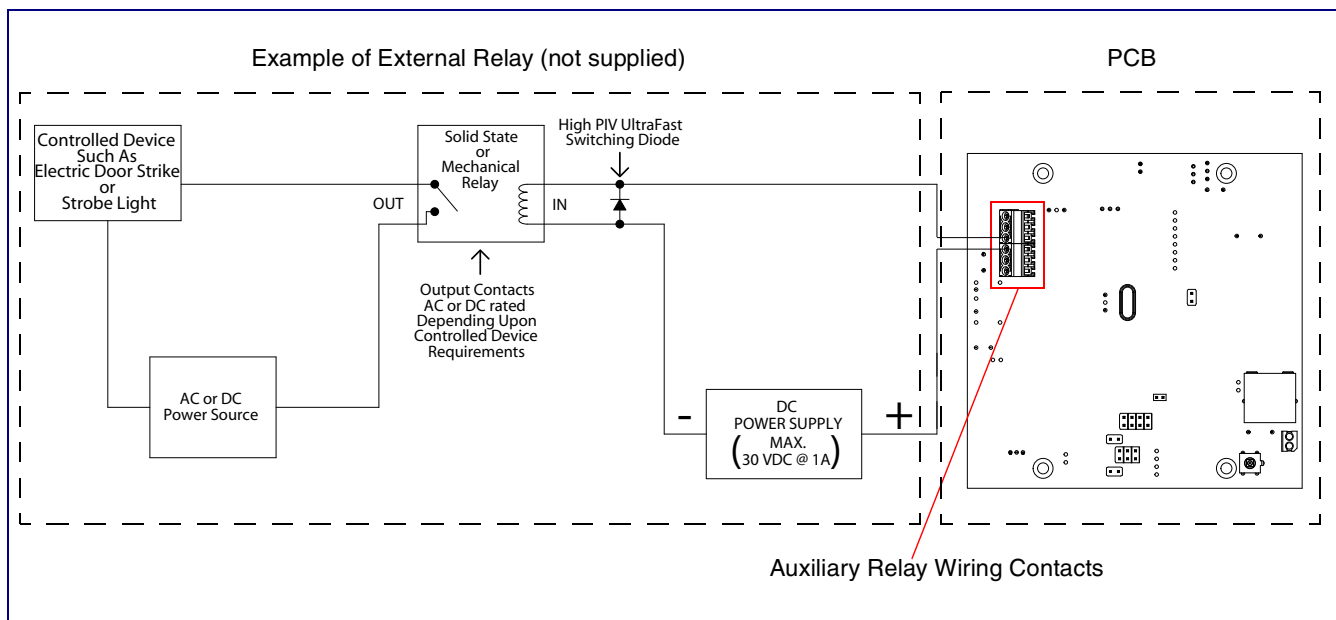

2.1.3 Identifying the SIP Strobe Connectors and Jumpers

See the following figures and tables to identify the SIP Strobe connector locations and functions.

Figure 2-3. Connector Locations

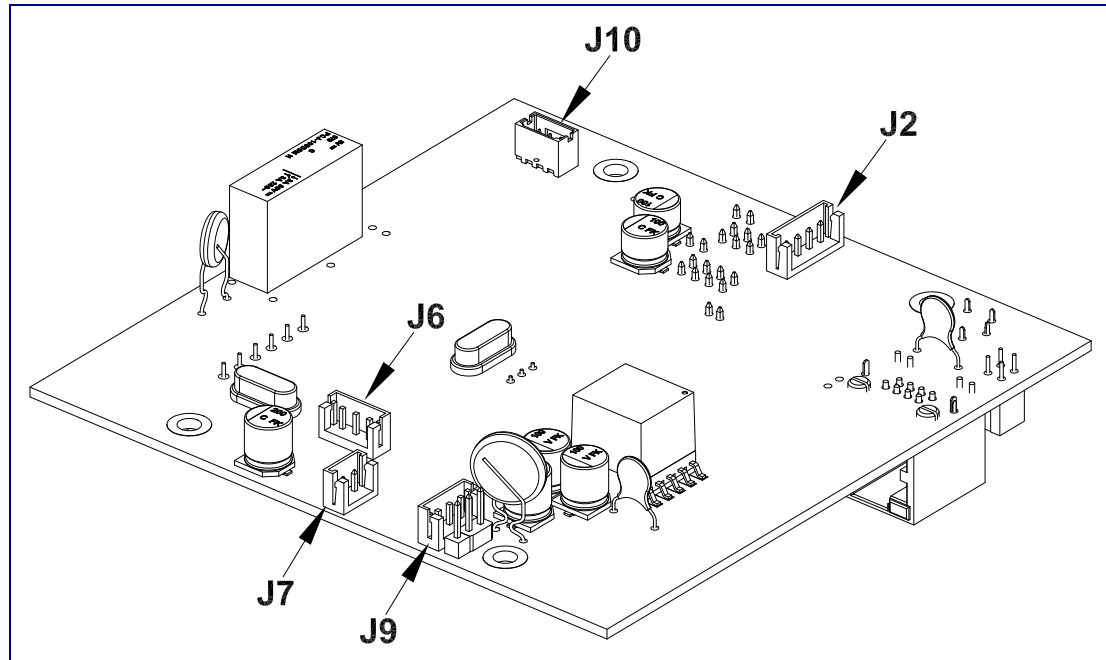

Table 2-2. Connector Functions

Connector	Function
J2	Call Button Interface — Not Used
J6	Microphone Interface — Not Used
J7	Speaker Interface — Not Used
J9	Strobe Power Interface — Not Used
J10	Proximity Sensor Interface — Not Used

Figure 2-4. Connector Locations

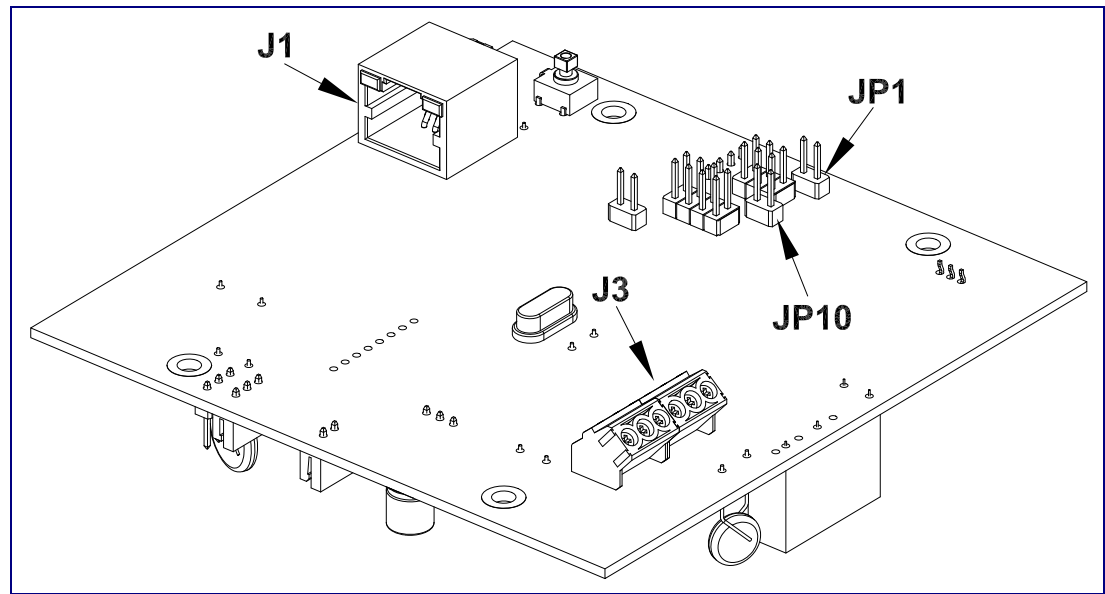

Table 2-3. Connector Functions

Connector	Function
J1	Ethernet Connector
J3	User Terminal Block Interface
JP1	Manual Reset — Factory only
JP10	Intrusion Sensor Disable. Place jumper on to disable.

2.1.4 Network Connectivity, and Data Rate

When you plug in the Ethernet cable or power supply:

- The square, green **Link** light above the Ethernet port indicates that the network connection has been established (see [Figure 2-5](#)).

Figure 2-5. Network Connector Prior to Installation

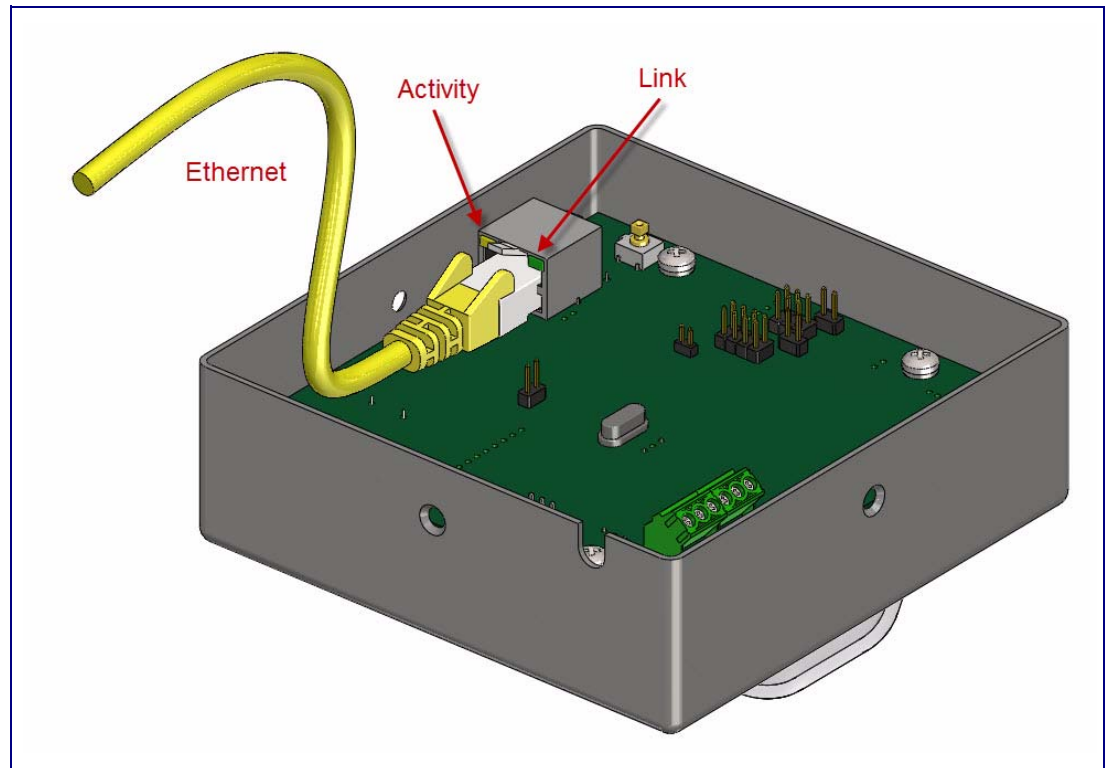

2.1.4.1 Verify Network Activity

The square, yellow **Activity** light blinks when there is network activity.

Figure 2-6. Network Connector

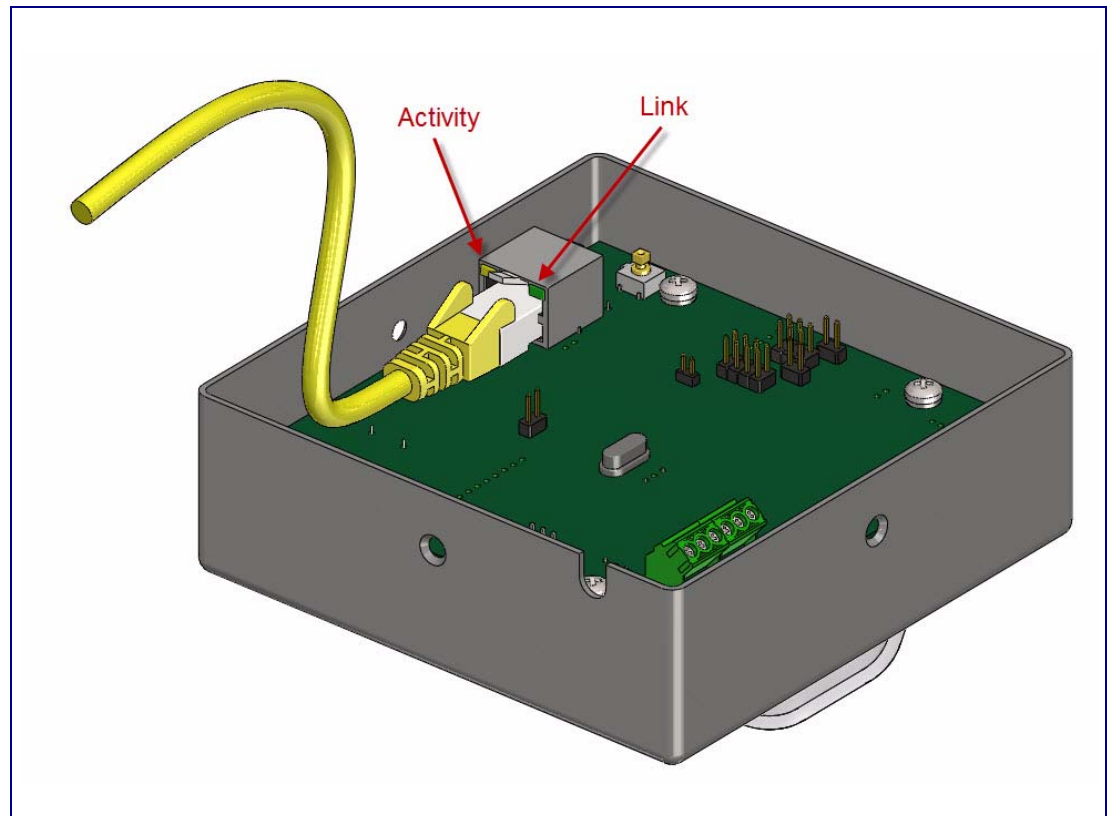

2.1.5 RTFM Switch

When the SIP Strobe is operational and linked to the network, use the Reset Test Function Management (**RTFM**) switch ([Figure 2-7](#)) on the SIP Strobe board to restore the unit to the factory default settings.

Figure 2-7. RTFM Switch

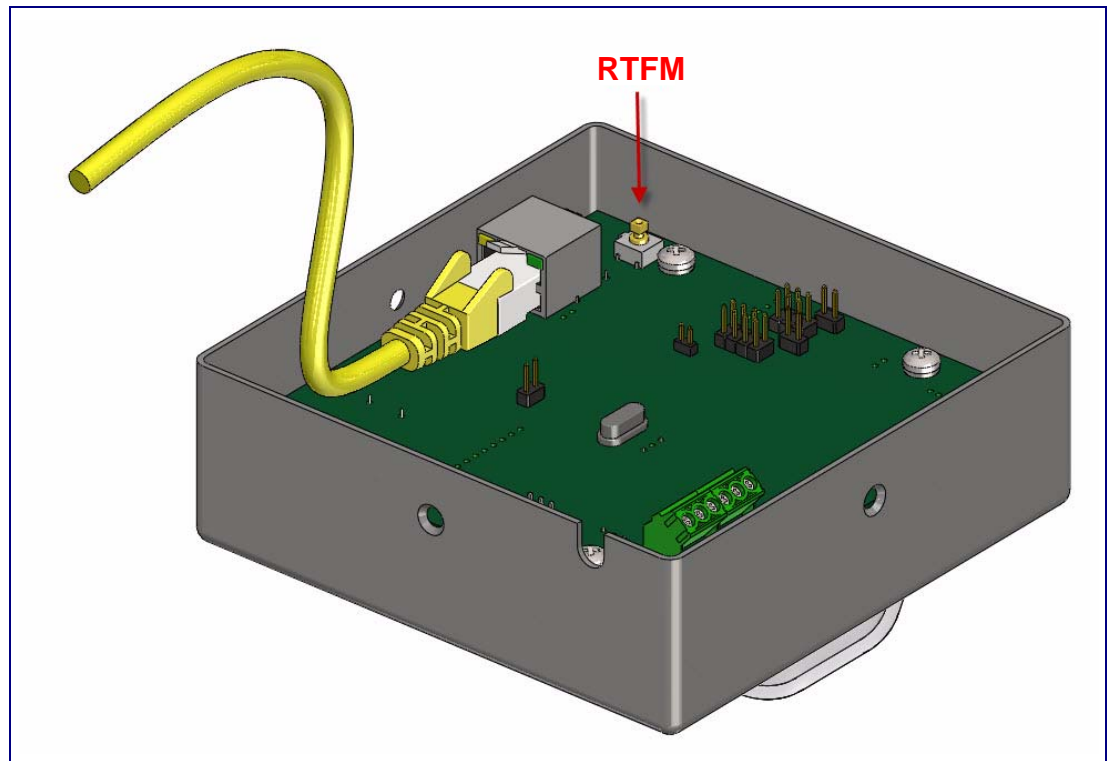

2.1.6 Restore the Factory Default Settings

2.1.6.1 RTFM Switch

When the SIP Strobe is operational and linked to the network, use the Reset Test Function Management (RTFM) switch (Figure 2-8) to set the factory default settings.

Note Each SIP Strobe is delivered with factory set default values.

Note The SIP Strobe will use DHCP to obtain the new IP address (DHCP-assigned address or default to 10.10.10.10 if a DHCP server is not present).

Figure 2-8. RTFM Switch

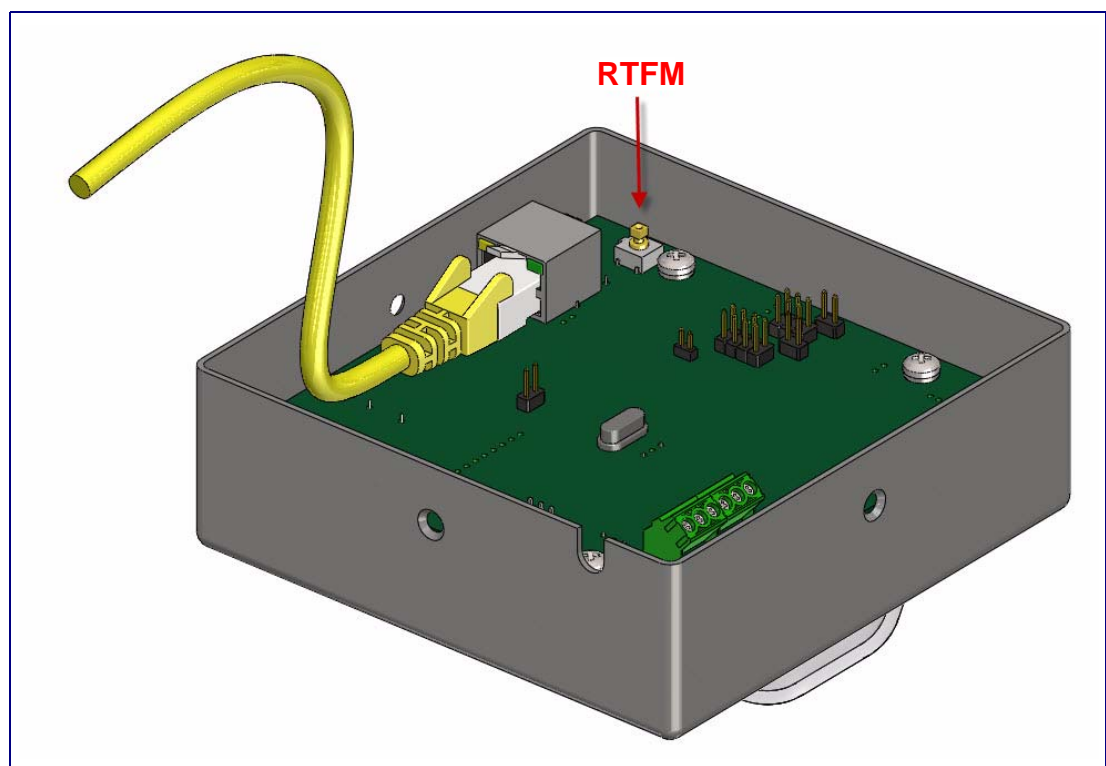

To set the factory default settings:

1. Press and hold the RTFM switch until the strobe flashes once (about eight seconds), and then release the RTFM switch.

2.2 Configure the SIP Strobe Parameters

To configure the SIP Strobe online, use a standard web browser.

Configure each SIP Strobe and verify its operation *before* you mount it. When you are ready to mount an SIP Strobe, refer to [Appendix A, "Mounting the SIP Strobe"](#) for instructions.

All SIP Strobes are initially configured with the following default IP settings:

When configuring more than one SIP Strobe, attach the SIP Strobes to the network and configure one at a time to avoid IP address conflicts.

Table 2-4. Factory Default Settings









Parameter	Factory Default Setting
IP Addressing	DHCP
IP Address ^a	10.10.10.10
Web Access Username	admin
Web Access Password	admin
Subnet Mask ^a	255.0.0.0
Default Gateway ^a	10.0.0.1

a. Default if there is not a DHCP server present.

2.2.1 SIP Strobe Web Page Navigation

Table 2-5 shows the navigation buttons that you will see on every SIP Strobe web page.

Table 2-5. Web Page Navigation

Web Page Item	Description
	Link to the Home page.
	Link to the Device Configuration page.
	Link to the Networking page.
	Link to the SIP Configuration page.
	Link to the Nightringer page.
	Link to the Sensor Configuration page.
	Link to the Event Configuration page.
	Link to the Autoprovisioning Configuration page.
	Link to the Update Firmware page.

2.2.2 Log in to the Configuration Home Page

1. Open your browser to the SIP Strobe IP address.

Note If the network does not have access to a DHCP server, the device will default to an IP address of 10.10.10.10.

Note Make sure that the PC is on the same IP network as the SIP Strobe.

Note You may also download CyberData's VoIP Discovery Utility program which allows you to easily find and configure the default web address of the CyberData VoIP products.

CyberData's VoIP Discovery Utility program is available at the following website address:

http://www.cyberdata.net/support/voip/discovery_utility.html

Note The SIP Strobe ships in DHCP mode. To get to the **Home** page, use the discovery utility to scan for the device on the network and open your browser from there.

2. When prompted, use the following default **Web Access Username** and **Web Access Password** to access the **Home Page** (Figure 2-9):

Web Access Username: **admin**

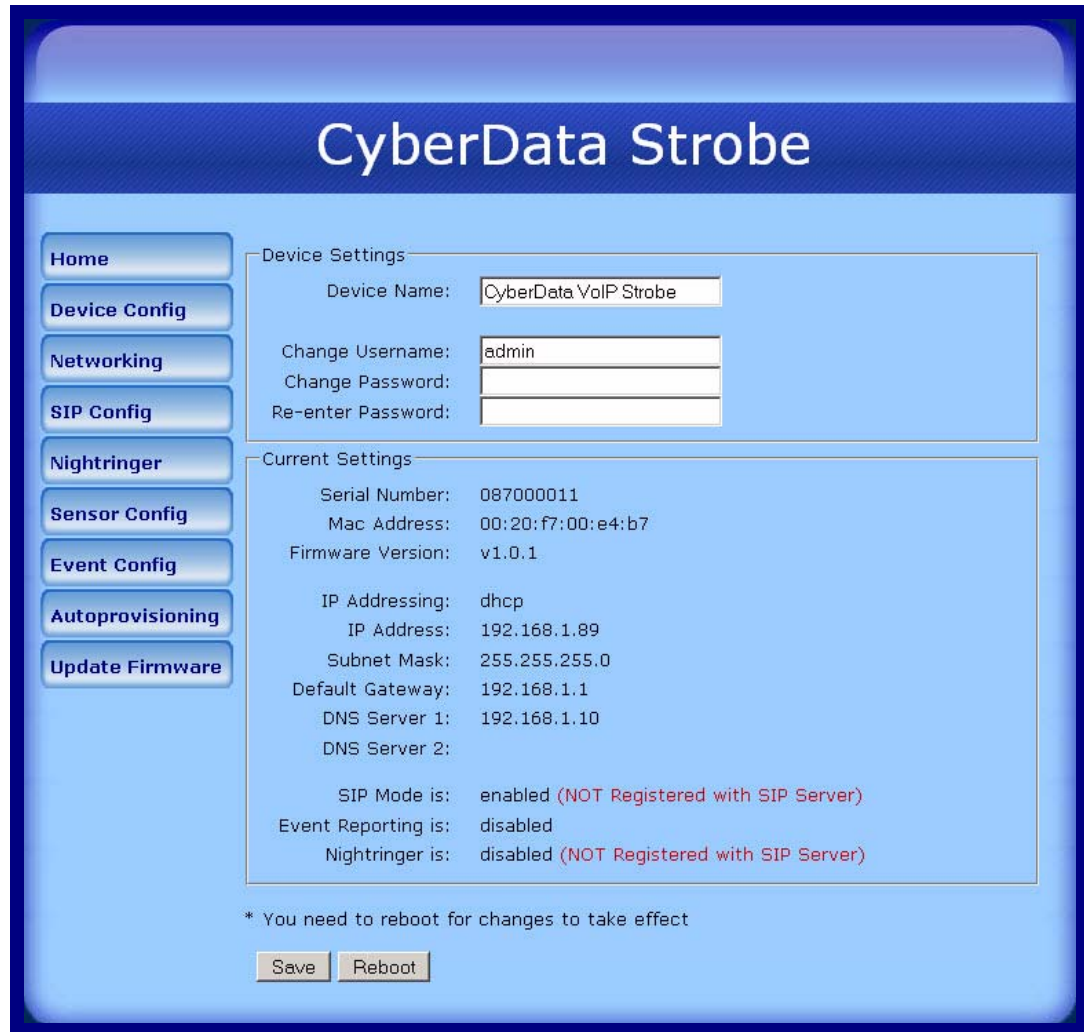

Web Access Password: **admin**

Figure 2-9. Home Page



3. On the **Home Page**, review the setup details and navigation buttons described in [Table 2-6](#).

Table 2-6. Home Page Overview

Web Page Item	Description
Device Settings	
Device Name	Shows the device name.
Change Username	Type in this field to change the username.
Change Password	Type in this field to change the password.
Re-enter Password	Type the password again in this field to confirm the new password.
Current Settings	
Serial Number	Shows the device serial number.
Mac Address	Shows the device Mac address.
Firmware Version	Shows the current firmware version.
IP Addressing	Shows the current IP addressing setting (DHCP or static).
IP Address	Shows the current IP address.
Subnet Mask	Shows the current subnet mask address.
Default Gateway	Shows the current default gateway address.
DNS Server 1	Shows the current DNS Server 1 address.
DNS Server 2	Shows the current DNS Server 2 address.
SIP Mode is	Shows the current status of the SIP mode.
Event Reporting is	Shows the current status of the Event Reporting mode.
Nightringer is	Shows the current status of the Nightringer mode.
	Click the Save button to save your configuration settings. Note: You need to reboot for changes to take effect.
	Click on the Reboot button to reboot the system.

2.2.3 Configure the Device



1. Click the **Device Configuration** button to open the **Device Configuration** page. See [Figure 2-10](#).

Figure 2-10. Device Configuration Page



2. On the **Device Configuration** page, you may enter values for the parameters indicated in [Table 2-7](#).

Table 2-7. Device Configuration Parameters

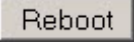
Web Page Item	Description
Relay Settings	
Activate Relay During Ring	When selected, the relay will be activated for as long as the call is ringing.
Activate Relay During Night Ring	Check this box to activate the relay for as long as a Night Ring tone is ringing.
	Click the Save button to save your configuration settings. Note: You need to reboot for changes to take effect.
	Click on the Test Relay button to do a relay test.
	Click on the Reboot button to reboot the system.

3. After changing the parameters, click the **Save** button.

2.2.4 Configure the Network Parameters

1. Click the **Networking** button to open the **Network Configuration** page (Figure 2-11).

Figure 2-11. Network Configuration Page

CyberData Strobe

Home
Device Config
Networking
SIP Config
Nightringer
Sensor Config
Event Config
Autoprovisioning
Update Firmware

Network Configuration

Stored Network Settings

IP Addressing: Static DHCP

IP Address: 10.10.10.10

Subnet Mask: 255.0.0.0

Default Gateway: 10.0.0.1

DNS Server 1: 10.0.0.1

DNS Server 2: 10.0.0.1

Current Network Settings

IP Address: 192.168.1.89

Subnet Mask: 255.255.255.0

Default Gateway: 192.168.1.1

DNS Server 1: 192.168.1.10



DNS Server 2:

* You need to reboot for changes to take effect

Save Reboot

2. On the **Network Configuration** page, enter values for the parameters indicated in [Table 2-8](#).

Table 2-8. Network Configuration Parameters

Web Page Item	Description
IP Addressing	Select either DHCP IP Addressing or Static IP Addressing by marking the appropriate radio button. If you select Static , configure the remaining parameters indicated in Table 2-8 . If you select DHCP , go to Step 3 .
Stored Network Settings	
IP Address	Enter the Static IP address.
Subnet Mask	Enter the Subnet Mask address.
Default Gateway	Enter the Default Gateway address.
DNS Server 1	Enter the DNS Server 1 address.
DNS Server 2	Enter the DNS Server 2 address.
Current Network Settings	
IP Address	Shows the current Static IP address.
Subnet Mask	Shows the current Subnet Mask address.
Default Gateway	Shows the current Default Gateway address.
DNS Server 1	Shows the current DNS Server 1 address.
DNS Server 2	Shows the current DNS Server 2 address.
	Click the Save button to save your configuration settings. Note: You need to reboot for changes to take effect.
	Click on the Reboot button to reboot the system.

3. After changing the parameters, click **Save Settings**. This updates the changed parameters and reboots the SIP Strobe if appropriate.
4. Connect the SIP Strobe to the target network.
5. From a system on the same network as the SIP Strobe, open a browser with the new IP address of the SIP Strobe.

2.2.5 Configure the SIP Parameters

1. Click **SIP Config** to open the **SIP Configuration** page (Figure 2-12).

Note For specific server configurations, go to the following website address:

<http://www.cyberdata.net/support/server/index.html>

Figure 2-12. SIP Configuration Page

CyberData Strobe

SIP Configuration

Enable SIP operation: (NOT Registered with SIP Server)

SIP Settings

SIP Server:	10.0.0.253
Remote SIP Port:	5060
Local SIP Port:	5060
Outbound Proxy:	
Outbound Proxy Port:	0
SIP User ID:	199
Authenticate ID:	199
Authenticate Password:	ext199

Register with a SIP Server:

Re-registration Interval (in seconds): 360

Unregister on Reboot:

Misc Settings



RTP Port (even):	10500
------------------	-------

* You need to reboot for changes to take effect

Save Reboot

2. On the **SIP Configuration** page, enter values for the parameters indicated in [Table 2-9](#).

Table 2-9. SIP Configuration Parameters

Web Page Item	Description
Enable SIP Operation	Enables or disables SIP operation.
SIP Settings	
SIP Server*	Type the SIP server represented as either a numeric IP address in dotted decimal notation or the fully qualified host name (255 character limit [FQDN]).
Remote SIP Port*	Type the Remote SIP Port number (default 5060) (8 character limit).
Local SIP Port*	Type the Local SIP Port number (default 5060) (8 character limit).
Outbound Proxy	Type the Outbound Proxy as either a numeric IP address in dotted decimal notation or the fully qualified host name (255 character limit [FQDN]).
Outbound Proxy Port	Type the Outbound Proxy Port number (8 character limit).
SIP User ID*	Type the SIP User ID (up to 64 alphanumeric characters).
Authenticate ID*	Type the Authenticate ID (up to 64 alphanumeric characters).
Authenticate Password*	Type the Authenticate Password (up to 64 alphanumeric characters).
Register with a SIP Server*	Check this box to enable SIP Registration.
Re-registration Interval (in seconds)*	Type the SIP Registration lease time in minutes (default is 60 minutes) (8 character limit). Re-registration Interval (in seconds)*
Unregister on Reboot*	When selected, on boot, the device will first register with a SIP server with a expiration delay of 0 seconds. This has the effect of unregistering any current devices on this extension.
Misc Settings	
RTP Port (even)	Specify the port number used for the RTP stream after establishing a SIP call. This port number has to be an even number and defaults to 10500.
	Click the Save button to save your configuration settings. Note: You need to reboot for changes to take effect.
	Click on the Reboot button to reboot the system.

3. After changing the parameters, click **Save Settings**.

2.2.6 Configure the Night Ringer Parameters

1. Click on the **Nightringer** button to open the **Nightringer Configuration** page. See [Figure 2-13](#).

Figure 2-13. Nightringer Configuration Setup

CyberData Strobe

Nightringer Configuration

Enable Nightringer: (NOT Registered with SIP Server)

Nightringer Settings

SIP Server:	10.0.0.253
Remote SIP Port:	5060
Local SIP Port:	5061
User ID:	241
Authenticate ID:	241
Authenticate Password:	ext241

Re-registration Interval (in seconds): 360

* You need to reboot for changes to take effect

Save Reboot

2. On the **Nightringer Configuration** page, enter values for the parameters indicated in [Table 2-10](#).

Table 2-10. Nightringer Configuration Parameters

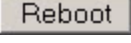
Web Page Item	Description
Enable Nightringer	When the nightringer is enabled, the ceiling speaker will attempt to register a second extension with the SIP server. Any calls made to this extension will play a ringtone.
Nightringer Settings	
SIP Server	Type the SIP server represented as either a numeric IP address in dotted decimal notation.
Remote SIP Port	Type the Remote SIP Port number (default 5060) (8 character limit).
Local SIP Port	Type the Local SIP Port number (default 5060) (8 character limit). Note: This value cannot be the same as the Local SIP Port* found on the SIP Configuration Page .
User ID	Type the User ID (up to 64 alphanumeric characters).
Authenticate ID	Type the Authenticate ID (up to 64 alphanumeric characters).
Authenticate Password	Type the Authenticate Password (up to 64 alphanumeric characters).
Re-registration Interval (in seconds)*	Type the SIP Registration lease time in minutes (default is 60 minutes) (8 character limit). Re-registration Interval (in seconds)*
	Click the Save button to save your configuration settings. Note: You need to reboot for changes to take effect.
	Click on the Reboot button to reboot the system.

3. After changing the parameters, click on the **Save** button.

2.2.7 Configure the Sensor Configuration Parameters

The sensor (pins 5 and 6) on the header can be used to monitor the open or closed state of a switch. There is an option on the **Sensor Configuration** page to trigger on an open or short condition on these pins.

The intrusion sensor is an optical sensor installed on the SIP Strobe board and will be activated when the SIP Strobe is removed from the case.

For each sensor there are two actions the SIP Strobe can take:

- Flash the LED until the sensor is deactivated (roughly 10 times/second)
- Activate the relay until the sensor is deactivated

1. Click **Sensor Config** to open the **Sensor Configuration** page (Figure 2-14).

Figure 2-14. Sensor Configuration Page

CyberData Strobe

Sensor Configuration

Home
Device Config
Networking
SIP Config
Nightringer
Sensor Config
Event Config
Autoprovisioning
Update Firmware

Sensor Settings

Sensor Normally Closed: Yes No

Activate Relay:

Blink Strobe:

Test Sensor

Intrusion Sensor Settings

Activate Relay:

Blink Strobe:



Test Intrusion Sensor

* You need to reboot for changes to take effect

Save Reboot

2. On the **Sensor Configuration** page, enter values for the parameters indicated in [Table 2-11](#).

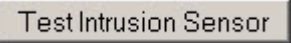
Table 2-11. Sensor Configuration Parameters

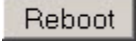
Web Page Item	Description
Sensor Settings	
Sensor Normally Closed	Select the inactive state of the sensors.
Activate Relay	Check this box to blink the strobe light until the sensor is deactivated.
Blink Strobe	Check this box to activate the blinking strobe until the sensor is deactivated.
	Use this button to test the sensor.
Intrusion Sensor Settings	
Activate Relay	Check this box to activate the relay until the sensor is deactivated.
Blink Strobe	Check this box to blink the strobe light until the sensor is deactivated.
	Use this button to test the Intrusion sensor.
	Click the Save button to save your configuration settings. Note: You need to reboot for changes to take effect.
	Click on the Reboot button to reboot the system.

3. After changing the parameters, click **Save Settings**.

2.2.8 Configure the Event Parameters

Click the **Event Config** button to open the **Event Configuration** page (Figure 2-15). The **Event Configuration** page specifies a remote server that can be used to receive HTTP POST events when actions take place on the board.

Figure 2-15. Event Configuration Page

CyberData Strobe

Event Configuration

Enable Event Generation:

Remote Event Server

Remote Event Server IP: 10.0.0.250

Remote Event Server Port: 8080

Remote Event Server URL: xmlparse_engine

Events

Enable Relay Activated Events:

Enable Relay Deactivated Events:

Enable Ring Events:

Enable Night Ring Events:

Enable Power on Events:

Enable 60 second Heartbeat Events:

* You need to reboot for changes to take effect

Save Test Event Reboot

Table 2-12 shows the web page items on the **Event Configuration** page.

Table 2-12. Event Configuration

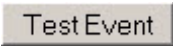
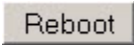
Web Page Item	Description
Enable Event Generation	When selected, Event Generation is enabled.
Remote Event Server	
Remote Event Server IP	Type the Remote Event Server IP address. (64 character limit)
Remote Event Server Port	Type the Remote Event Server port number. (8 character limit)
Remote Event Server URL	Type the Remote Event Server URL. (127 character limit)
Events	
Enable Relay Activated Events	When selected, Relay Activated Events are enabled.
Enable Relay Deactivated Events	When selected, Relay Deactivated Events are enabled.
Enable Ring Events	When selected, Ring Events are enabled.
Enable Night Ring Events	When selected, there is a notification when the device receives a night ring.
Enable Power On Events	When selected, Power On Events are enabled.
Enable 60 Second Heartbeat Events	When selected, 60 Second Heartbeat Events are enabled.
	Click the Save button to save your configuration settings. Note: You need to reboot for changes to take effect.
	Click on the Test Event button to test an event.
	Click on the Reboot button to reboot the system.

2.2.8.1 Example Packets for Events

The server and port are used to point to the listening server and the 'Remote Event Server URL' is the destination URL (typically the script running on the remote server that's used to parse and process the POST events).

Note The XML is URL-encoded before transmission so the following examples are not completely accurate.

Here are example packets for every event:

```
POST xmlparse_engine HTTP/1.1
Host: 10.0.3.79
User-Agent: CyberData/1.0.0
Content-Length: 197
Content-Type: application/x-www-form-urlencoded

<?xml version="1.0" encoding="ISO-8859-1"?>
<cyberdata NAME='CyberData SIP Device' MAC='0020f70015b6'>
<event>POWERON</event>
</cyberdata>
```

```
POST xmlparse_engine HTTP/1.1
Host: 10.0.3.79
User-Agent: CyberData/1.0.0
Content-Length: 199
Content-Type: application/x-www-form-urlencoded

<?xml version="1.0" encoding="ISO-8859-1"?>
<cyberdata NAME='CyberData SIP Device' MAC='0020f70015b6'>
<event>HEARTBEAT</event>
</cyberdata>
```

```
POST xmlparse_engine HTTP/1.1
Host: 10.0.3.79
User-Agent: CyberData/1.0.0
Content-Length: 196
Content-Type: application/x-www-form-urlencoded

<?xml version="1.0" encoding="ISO-8859-1"?>
<cyberdata NAME='CyberData SIP Device' MAC='0020f70015b6'>
<event>BUTTON</event>
</cyberdata>
```

```
POST xmlparse_engine HTTP/1.1
Host: 10.0.3.79
User-Agent: CyberData/1.0.0
Content-Length: 201
Content-Type: application/x-www-form-urlencoded

<?xml version="1.0" encoding="ISO-8859-1"?>
<cyberdata NAME='CyberData SIP Device' MAC='0020f70015b6'>
<event>CALL_ACTIVE</event>
</cyberdata>
POST xmlparse_engine HTTP/1.1
```

```
Host: 10.0.3.79
User-Agent: CyberData/1.0.0
Content-Length: 205
Content-Type: application/x-www-form-urlencoded

<?xml version="1.0" encoding="ISO-8859-1"?>
<cyberdata NAME='CyberData SIP Device' MAC='0020f70015b6'>
<event>CALL_TERMINATED</event>
</cyberdata>

POST xmlparse_engine HTTP/1.1
Host: 10.0.3.79
User-Agent: CyberData/1.0.0
Content-Length: 197
Content-Type: application/x-www-form-urlencoded

<?xml version="1.0" encoding="ISO-8859-1"?>
<cyberdata NAME='CyberData SIP Device' MAC='0020f70015b6'>
<event>RINGING</event>
</cyberdata>

POST xmlparse_engine HTTP/1.1
Host: 10.0.3.79
User-Agent: CyberData/1.0.0
Content-Length: 234
Content-Type: application/x-www-form-urlencoded

<?xml version="1.0" encoding="ISO-8859-1"?>
<cyberdata NAME='CyberData SIP Device' MAC='0020f70015b6'>
<event>MULTICAST_START</event>
<index>8</index>
</cyberdata>

POST xmlparse_engine HTTP/1.1
Host: 10.0.3.79
User-Agent: CyberData/1.0.0
Content-Length: 233
Content-Type: application/x-www-form-urlencoded

<?xml version="1.0" encoding="ISO-8859-1"?>
<cyberdata NAME='CyberData SIP Device' MAC='0020f70015b6'>
<event>MULTICAST_STOP</event>
<index>8</index>
</cyberdata>

POST xmlparse_engine HTTP/1.1
Host: 10.0.3.79
User-Agent: CyberData/1.0.0
Content-Length: 234
Content-Type: application/x-www-form-urlencoded
<?xml version="1.0" encoding="ISO-8859-1"?>
<cyberdata NAME='CyberData SIP Device' MAC='0020f70015b6'>
<event>RELAY_ACTIVATED</event>
</cyberdata>
POST xmlparse_engine HTTP/1.1
```

```
Host: 10.0.3.79
User-Agent: CyberData/1.0.0
Content-Length: 234
Content-Type: application/x-www-form-urlencoded
<?xml version="1.0" encoding="ISO-8859-1"?>
<cyberdata NAME='CyberData SIP Device' MAC='0020f70015b6'>
<event>RELAY_DEACTIVATED</event>
</cyberdata>
```

```
POST xmlparse_engine HTTP/1.1
Host: 10.0.3.79
User-Agent: CyberData/1.0.0
Content-Length: 234
Content-Type: application/x-www-form-urlencoded
<?xml version="1.0" encoding="ISO-8859-1"?>
<cyberdata NAME='CyberData SIP Device' MAC='0020f70015b6'>
<event>NIGHTRINGING</event>
</cyberdata>
```

2.2.9 Configure the Autoprovisioning Parameters

1. Click the **Autoprovisioning** button to open the **Autoprovisioning Configuration** page. See [Figure 2-16](#).

Figure 2-16. Autoprovisioning Configuration Page

CyberData Strobe

Home
Device Config
Networking
SIP Config
Nightringer
Sensor Config
Event Config
Autoprovisioning
Update Firmware

Autoprovisioning

Autoprovisioning

Enable Autoprovisioning:

Get Autoprovisioning from DHCP:

Autoprovisioning Server (IP Address):

Autoprovisioning autoupdate (in minutes):

* Autoprovisioning file name: 0020f700e4b7.config

* You need to reboot for changes to take effect

Save Reboot

2. On the **Autoprovisioning Configuration** page, you may enter values for the parameters indicated in [Table 2-13](#).

Table 2-13. Autoprovisioning Configuration Parameters

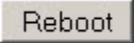
Web Page Item	Description
Autoprovisioning	
Enable Autoprovisioning	See Section 2.2.9.1, "Autoprovisioning" .
Get Autoprovisioning from DHCP	See Section 2.2.9.1, "Autoprovisioning" .
Autoprovisioning Server (IP Address)	See Section 2.2.9.1, "Autoprovisioning" (15 character limit).
Autoprovisioning Autoupdate (in minutes)	Type the desired time (in minutes) that you want the Autoprovisioning feature to update (6 character limit).
Autoprovisioning file name	Displays the current autoprovisioning file name.
	Click the Save button to save your configuration settings. Note: You need to reboot for changes to take effect.
	Click on the Reboot button to reboot the system.

3. After changing the parameters, click the **Save** button.

2.2.9.1 Autoprovisioning

Enable Autoprovisioning Option With autoprovisioning enabled, the board will get its configuration from a remote TFTP server on startup or periodically on a scheduled delay. Autoprovisioned values will override values stored in on-board memory and will be visible on the web page. The board gets its autoprovisioning information from an XML-formatted file hosted from a TFTP server. CyberData will provide a template for this XML file and the user can modify it for their own use.

To use autoprovisioning, create a copy of the autoprovisioning template with the desired settings and name this file with the mac address of the device to configure (for example: **0020f7350058.config**). Put this file into your TFTP server directory and manually set the TFTP server address on the board.

It is not necessary to set every option found in the autoprovisioning template. As long as the XML is valid, the file can contain any subset. Options not autoprovisioned will default to the values stored in the on board memory. For example if you only wanted to modify the device name, the following would be a valid autoprovisioning file:

```
<?xml version="1.0" encoding="utf-8" ?>
<specific>
  <MiscSettings>
    <DeviceName>auto SIP Strobe</DeviceName>
  </MiscSettings>
</specific>
```

Networking The board will only apply networking settings or firmware upgrades after a reboot.

Get Autoprovisioning from DHCP When this option is checked, the device will automatically fetch its autoprovisioning server address from the DHCP server. The device will use the address specified in **OPTION 150** (TFTP-server-name) or **OPTION 66**. If both options are set, the device will use **OPTION 150**.

Refer to the documentation of your DHCP server for setting up **OPTION 150**.

To set up a Linux DHCPD server to serve autoprovisioning information (in this case using both option 66 and 150), here's an example dhcpd.conf:

```
# dhcpd.conf
#
# Configuration file for ISC dhcpd (see 'man dhcpd.conf')
#
ddns-update-style ad-hoc;

option option-150 code 150 = ip-address;

subnet 10.0.0.0 netmask 255.0.0.0 {
    max-lease-time 120;
    default-lease-time 120;

    option routers                10.0.0.1;
    option subnet-mask            255.0.0.0;

    option domain-name            "voiplab";
    option domain-name-servers    10.0.0.1;

    option time-offset            -8;      # Pacific Standard Time

    option tftp-server-name       "10.0.0.254";

    option option-150             10.0.0.254;

    range 10.10.0.1 10.10.2.1;}

```

Autoprovisioning Server (IP Address) Instead of using DHCP to provide the autoprovisioning tftp server address, you can specify an address manually.

Autoprovisioning Autoupdate If **Autoprovisioning** is enabled and the **Autoprovisioning Autoupdate** value is something other than 0 minutes, a service is started on startup that will wait the configured number of minutes and then try to re-download its autoprovisioning file. It will compare its previously autoprovisioned file with this new file and if there are differences, it will reboot the board.

Autoprovisioned Firmware Upgrades An Autoprovisioned firmware upgrade only happens after a reboot, will take roughly three minutes, and the web page will be unresponsive during this time.

The '**FirmwareVersion**' value in the xml file *must* match the version stored in the '**FirmwareFile**'.

```
<FirmwareVersion>v5.0.5b01</FirmwareVersion>
<FirmwareFile>505b01-uImage-SIP Strobe</FirmwareFile>

```

If these values are mismatched, the board can get stuck in a loop where it goes through the following sequence of actions:

1. The board downloads and writes a new firmware file.
2. After the next reboot, the board recognizes that the firmware version does not match.
3. The board downloads and writes the firmware file again.

CyberData has timed a firmware upgrade at 140 seconds. Therefore, if you suspect the board is stuck in a loop, either remove or comment out the **FirmwareVersion** line in the XML file and let the board boot as it normally does.

2.3 Upgrade the Firmware and Reboot the SIP Strobe

Note To guard against failed firmware upgrades, units shipped from CyberData with firmware version 1.0.2 and later feature a built-in "fail safe" mechanism.

To upload the firmware from your computer:

1. Retrieve the latest SIP Strobe firmware file from the SIP Strobe **Downloads** page at:
<http://www.cyberdata.net/products/voip/digitalanalog/strobe/downloads.html>
2. Unzip the firmware version file. This file may contain the following:
 - Firmware file
 - Release notes
3. Log in to the SIP Strobe home page as instructed in [Section 2.2.2, "Log in to the Configuration Home Page"](#).
4. Click the **Update Firmware** button to open the **Upgrade Firmware** page. See [Figure 2-17](#).

Figure 2-17. Upgrade Firmware Page



The screenshot shows the 'Upgrade Firmware' page in the CyberData Strobe web interface. The page has a blue header with the text 'CyberData Strobe'. On the left side, there is a vertical menu with buttons for 'Home', 'Device Config', 'Networking', 'SIP Config', 'Nightringer', 'Sensor Config', 'Event Config', 'Autoprovisioning', and 'Update Firmware'. The main content area is titled 'Upgrade Firmware' and contains a 'File Upload' section. This section displays 'Firmware Version: v1.0.1' and a text input field with the prompt 'Please specify a file:'. To the right of the input field is a 'Browse...' button. At the bottom of the page, there is a message 'System will automatically reboot after upgrading firmware' and two buttons: 'Submit' and 'Reboot'.

5. Select **Browse**, and then navigate to the location of the SIP Strobe firmware file.
6. Click **Submit**.

Note This starts the upgrade process. Once the SIP Strobe has uploaded the file, the **Uploading Firmware** countdown page appears, indicating that the firmware is being written to flash. The SIP Strobe will automatically reboot when the upload is complete. When the countdown finishes, the **Upgrade Firmware** page will refresh. The uploaded firmware filename should be displayed in the system configuration (indicating successful upload and reboot).

Table 2-14 shows the web page items on the **Upgrade Firmware** page.

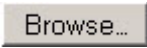
Table 2-14. Firmware Upgrade Parameters

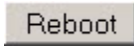
Web Page Item	Description
File Upload	
Firmware Version	Shows the current firmware version.
	Use the Browse button to navigate to the location of the firmware file that you want to upload.
	Click on the Submit button to automatically upload the selected firmware and reboot the system.
	Click on the Reboot button to reboot the system.

2.3.1 Reboot the SIP Strobe

To reboot a SIP Strobe, log in to the web page as instructed in [Section 2.2.2, "Log in to the Configuration Home Page"](#).

1. Click **Update Firmware** to open the **Upgrade Firmware** page ([Figure 2-18](#)).

Figure 2-18. Reboot System Section

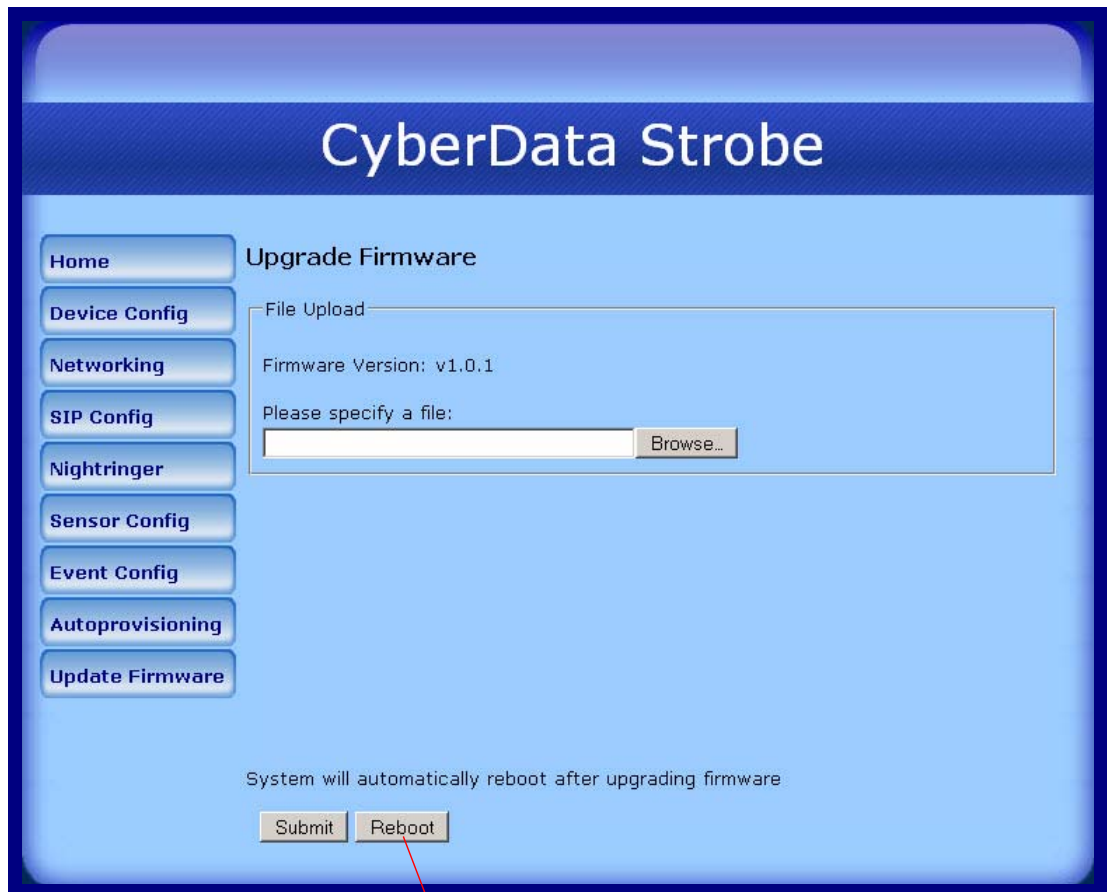

Reboot

2. Click **Reboot**. A normal restart will occur.

Appendix A: Mounting the SIP Strobe

A.1 Mount the SIP Strobe

Before you mount the SIP Strobe, make sure that you have received all the parts for each SIP Strobe. Refer to [Table A-1](#).

Table A-1. Wall Mounting Components (Part of the Accessory Kit)

Quantity	Part Name	Illustration
4	#6 x 1.5 inches Sheet Metal Screw	
4	#6 Ribbed Plastic Anchor	

Table A-2. Gang Box Mounting Components

Quantity	Part Name	Illustration
4	#6-32 x 0.625-inch Flat-Head Machine Screw.	

After the SIP Strobe is assembled, plug the Ethernet cable into the SIP Strobe Assembly (see [Figure A-19](#)).

[Section 2.1.4, "Network Connectivity, and Data Rate"](#) explains how the **Link** and **Status** LEDs work.

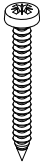
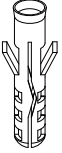
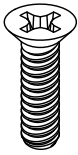
Figure A-19. Network Connector Prior to Installation

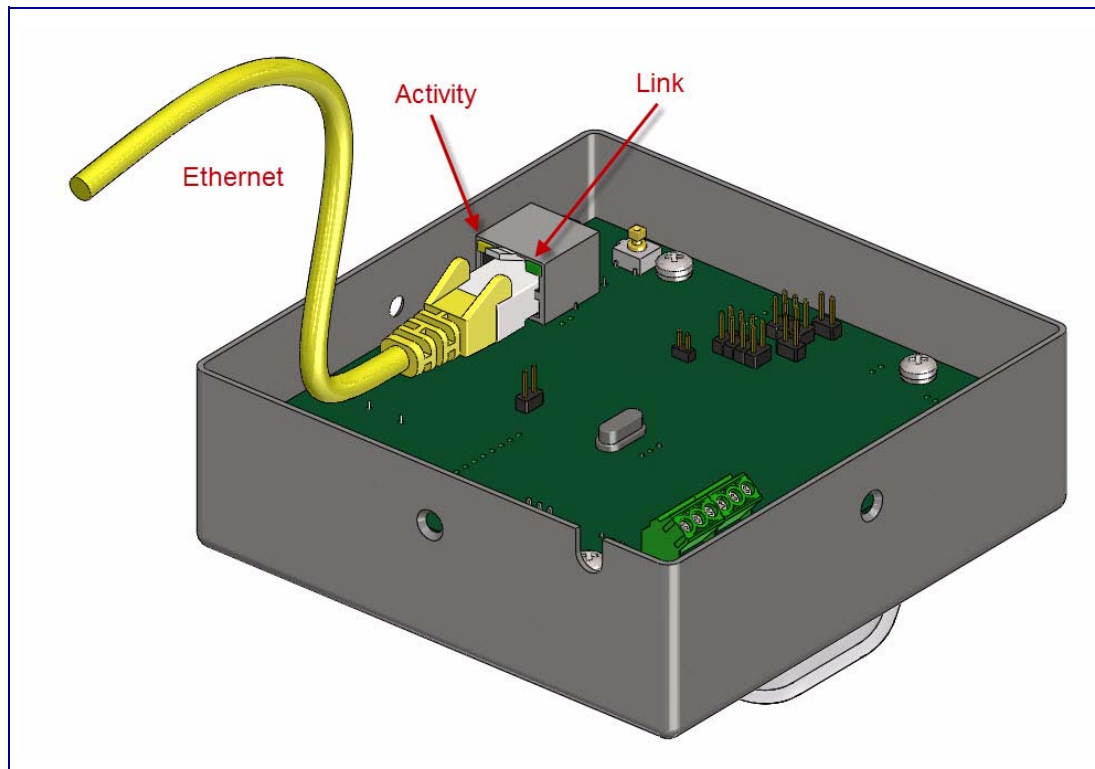

Figure A-20 shows the mounting options for the SIP Strobe.

Note Be sure to connect the SIP Strobe up to the Earth Ground.

Figure A-20. Mounting Options

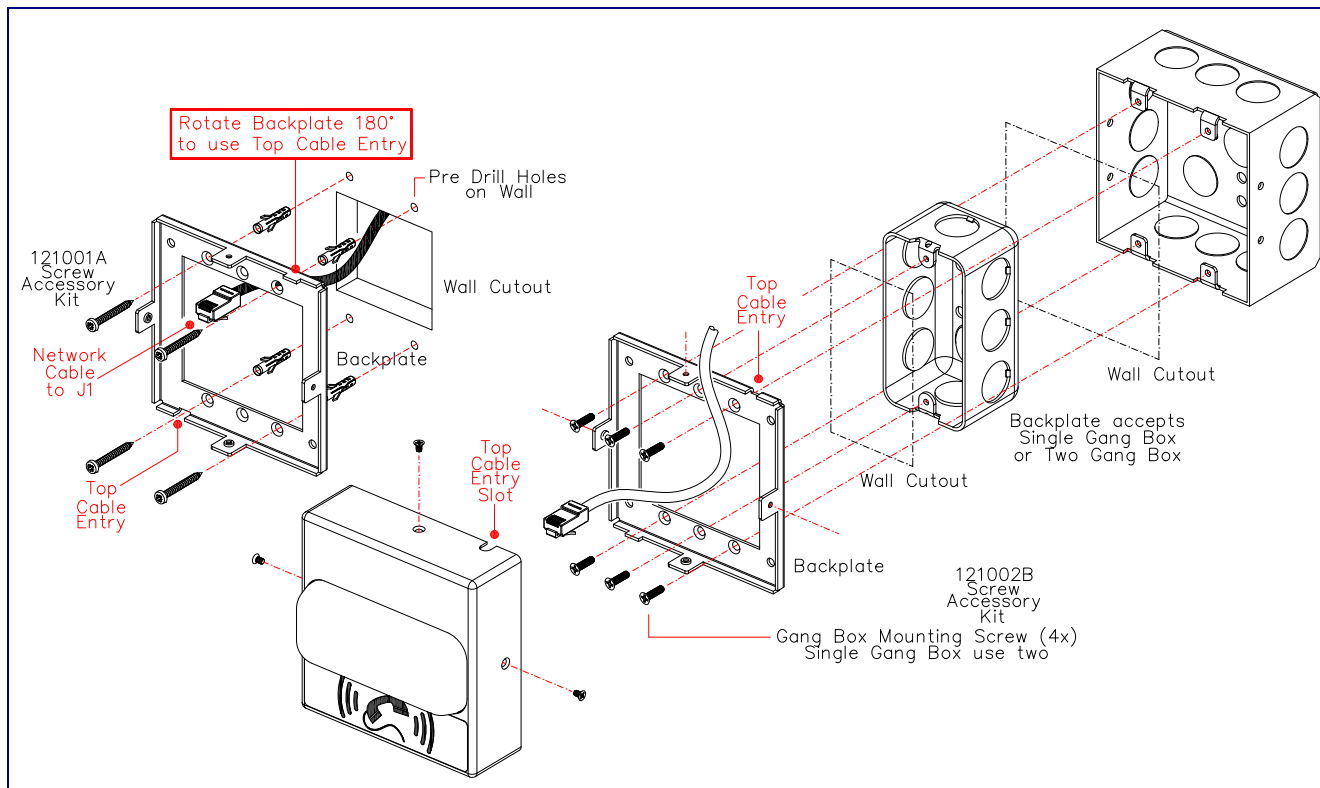
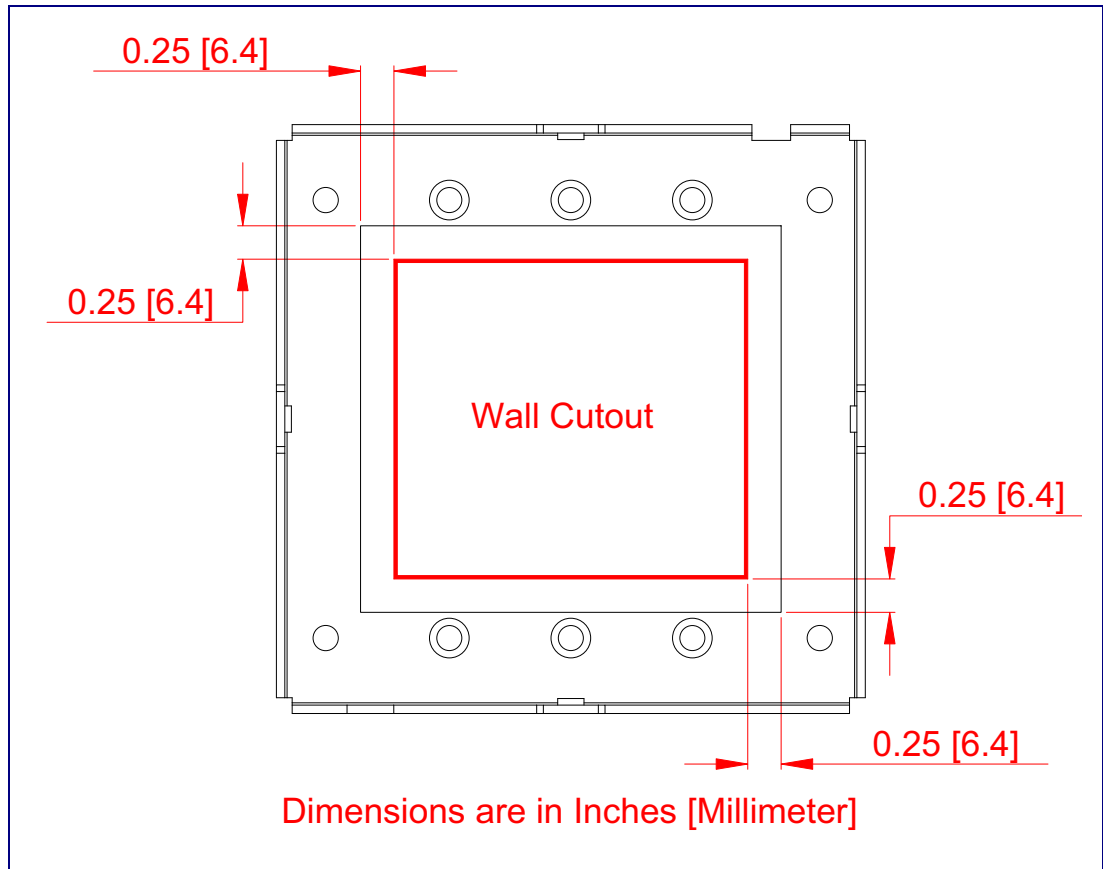

Figure A-21 shows the maximum recommended wall cutout dimensions for mounting the SIP Strobe.

Figure A-21. Maximum Recommended Wall Cutout Dimensions



Appendix B: Troubleshooting/Technical Support

B.1 Frequently Asked Questions (FAQ)

A list of frequently asked questions (FAQs) are available on the SIP Strobe product page at:

<http://www.cyberdata.net/products/voip/digitalanalog/strobe/faqs.html>

Select the support page for your product to see a list of frequently asked questions for the CyberData product:

B.2 Documentation

The documentation for this product is released in an English language version only. You can download PDF copies of CyberData product documentation from the SIP Strobe product page at:

<http://www.cyberdata.net/products/voip/digitalanalog/strobe/docs.html>

B.3 Contact Information

Contact	<p>CyberData Corporation 3 Justin Court Monterey, CA 93940 USA www.CyberData.net Phone: 800-CYBERDATA (800-292-3732) Fax: 831-373-4193</p>
Sales	<p>Sales 831-373-2601 Extension 334</p>
Technical Support	<p>The fastest way to get technical support for your VoIP product is to submit a VoIP Technical Support form at the following website:</p> <p>http://www.cyberdata.net/support/contactsupportvoip.html</p> <p>We have several technical support staff monitoring this form and they will contact you within 12 hours after receiving a form submission.</p> <p>Phone: (831) 373-2601, Ext. 333 Email: support@cyberdata.net</p>
Returned Materials Authorization	<p>To return the product, contact the Returned Materials Authorization (RMA) department:</p> <p>Phone: 831-373-2601, Extension 136 Email: RMA@CyberData.net</p> <p>When returning a product to CyberData, an approved CyberData RMA number must be printed on the outside of the original shipping package. No product will be accepted for return without an approved RMA number. Send the product, in its original package, to the following address:</p> <p>CyberData Corporation 3 Justin Court Monterey, CA 93940 Attention: RMA "your RMA number"</p>
RMA Status Form	<p>If you need to inquire about the repair status of your product(s), please use the CyberData RMA Status form at the following web address:</p> <p>http://www.cyberdata.net/support/rmastatus.html</p>

B.4 Warranty

CyberData warrants its product against defects in material or workmanship for a period of two years from the date of purchase. Should the product fail within the warranty period, CyberData will repair or replace the product free of charge. This warranty includes all parts and labor.

Should the product fail out-of-warranty, a flat rate repair charge of one half of the purchase price of the product will be assessed. Repairs that are in warranty but are damaged by improper modifications or abuse, will be charged at the out-of-warranty rate. Products shipped to CyberData, both in and out-of-warranty, are shipped at the expense of the customer. Shipping charges for repaired products shipped back to the customer by CyberData, will be paid by CyberData.

CyberData shall not under any circumstances be liable to any person for any special, incidental, indirect or consequential damages, including without limitation, damages resulting from use or malfunction of the products, loss of profits or revenues or costs of replacement goods, even if CyberData is informed in advance of the possibility of such damages.

B.4.1 Warranty & RMA Returns within the United States

If service is required, you must contact CyberData Technical Support prior to returning any products to CyberData. Our Technical Support staff will determine if your product should be returned to us for further inspection. If Technical Support determines that your product needs to be returned to CyberData, an RMA number will be issued to you at this point.

Your issued RMA number must be printed on the outside of the shipping box. No product will be accepted for return without an approved RMA number. The product in its original package should be sent to the following address:

CyberData Corporation
3 Justin Court.
Monterey, CA 93940
Attn: RMA "xxxxxx"

B.4.2 Warranty & RMA Returns Outside of the United States

If you purchased your equipment through an authorized international distributor or reseller, please contact them directly for product repairs.

B.4.3 Spare in the Air Policy

CyberData now offers a *Spare in the Air* no wait policy for warranty returns within the United States and Canada. More information about the *Spare in the Air* policy is available at the following web address:

<http://www.cyberdata.net/support/warranty/spareintheair.html>

B.4.4 Return and Restocking Policy

For our authorized distributors and resellers, please refer to your CyberData Service Agreement for information on our return guidelines and procedures.

For End Users, please contact the company that you purchased your equipment from for their return policy.

B.4.5 Warranty and RMA Returns Page

The most recent warranty and RMA information is available at the CyberData Warranty and RMA Returns Page at the following web address:

<http://www.cyberdata.net/support/warranty/index.html>

Index

A

- AC voltages 2, 7
- act light 11
- activate relay (intrusion sensor) 28
- activate relay (sensor) 28
- address, configuration login 16
- announcing a speaker's IP address 13
- audio encodings 3
- autoprovisioning 36
 - autoprovisioned firmware upgrades 37
 - autoprovisioning autoupdate 37
 - autoprovisioning enabled option 36
 - autoprovisioning from DHCP 36
 - autoprovisioning server (IP address) 37
 - networking 36
- autoprovisioning configuration 34, 35
- auxiliary relay wiring diagram 7

B

- baud rate
 - verifying 10
- blink strobe (intrusion sensor) 28
- blink strobe (sensor) 28

C

- changing
 - the web access password 19
- configurable parameters 18, 20, 22, 24, 39
- configuration
 - default IP settings 14
 - door sensor 27
 - intrusion sensor 27
 - network 21
 - SIP 23
 - using Web interface 14
- configuration home page 17
- configuration page
 - configurable parameters 18, 20, 22, 24, 39
- contact information 46
- contact information for CyberData 46
- Current Network Settings 22
- current network settings 22
- CyberData contact information 46

D

- default
 - device settings 49
 - gateway 14
 - IP address 14
 - subnet mask 14
 - username and password 14
 - web login username and password 17
- default device settings 13
- default gateway 14, 22
- default IP settings 14
- default login address 16
- device configuration 19
 - device configuration parameters 35
 - the device configuration page 34
- device configuration page 19
- device configuration parameters 20
- device configuration password
 - changing for web configuration access 19
- DHCP Client 3
- DHCP IP addressing 22
- dimensions 4
- discovery utility program 16
- DNS server 22
- door sensor 28

E

- earth ground 43
- enable night ring events 30
- ethernet cable 42
- event configuration
 - enable night ring events 30
- expiration time for SIP server lease 24, 26

F

- factory default settings 13
 - how to set 13
- firmware
 - where to get the latest firmware 38

G

- gang box mounting 43

green link light 10

H

home page 17

http web-based configuration 3

I

identifying your product 1

illustration of device mounting process 41

installation, typical device system 2

intrusion sensor 27, 28

activate relay 28

IP address 14, 22

IP addressing 22

default

IP addressing setting 14

L

lease, SIP server expiration time 24, 26

link LED 42

link light 10

local SIP port 24

log in address 16

M

mounting the device 41

N

navigation (web page) 15

navigation table 15

network activity, verifying 11

network configuration 21

network rate 4

Network Setup 21

nightringer settings 26

P

packet time 3

part number 4

parts list 5

password

for SIP server login 24

login 17

restoring the default 14

port

local SIP 24

remote SIP 24

power requirement 4

product

configuring 14

mounting 41

parts list 5

product features 3

product overview

product features 3

product specifications 4

supported protocols 3

supported SIP servers 3

typical system installation 2

product specifications 4

protocols supported 3

R

reboot 39, 40

remote SIP port 24

Reset Test Function Management (RTFM) switch 13

reset test function management switch 12

resetting the IP address to the default 41, 45

restoring factory default settings 13, 49

restoring the factory default settings 13

return and restocking policy 48

RMA returned materials authorization 46

RMA status 46

RTFM jumper 12

RTFM switch 12, 13

RTP/AVP 3

S

sales 46

sensor 28

activate relay 28

blink strobe 28

sensor normally closed 28

sensor setup page 27

sensor setup parameters 27

sensors 28

server address, SIP 24

service 46

setting up the device 6

- settings, default 13
- SIP
 - enable SIP operation 24
 - local SIP port 24
 - user ID 24
- SIP (session initiation protocol) 3
- SIP configuration 23
 - SIP Server 24
- SIP configuration parameters
 - outbound proxy 24
 - registration and expiration, SIP server lease 24, 26
 - unregister on reboot 24
 - user ID, SIP 24
- SIP registration 24
- SIP remote SIP port 24
- SIP server 24
 - password for login 24
 - SIP servers supported 3
 - unregister from 24
 - user ID for login 24
- Spare in the Air Policy 47
- static IP addressing 22
- status LED 42
- subnet mask 14, 22
- supported protocols 3

T

- tech support 46
- technical support, contact information 46

U

- user ID
 - for SIP server login 24
- username
 - changing for web configuration access 19
 - default for web configuration access 17
 - restoring the default 14

V

- verifying
 - baud rate 10
 - network activity 11
 - network connectivity 10

W

- warranty 47
- warranty & RMA returns outside of the United States 47
- warranty & RMA returns within the United States 47
- warranty and RMA returns page 48
- warranty policy at CyberData 47
- web access password 14
- web access username 14
- web configuration log in address 16
- web page
 - navigation 15
- web page navigation 15
- web-based configuration 14
- weight 4

Y

- yellow act light 11