



VoIP V2 Paging Amplifier Operations Guide

Part #011061
Document Part #930324D
for Firmware Version 1.1.2

CyberData Corporation
2555 Garden Road
Monterey, CA 93940
(831) 373-2601

VoIP V2 Paging Amplifier Operations Guide 930324D
Part # 011061

COPYRIGHT NOTICE:

© 2010, CyberData Corporation, ALL RIGHTS RESERVED.

This manual and related materials are the copyrighted property of CyberData Corporation. No part of this manual or related materials may be reproduced or transmitted, in any form or by any means (except for internal use by licensed customers), without prior express written permission of CyberData Corporation. This manual, and the products, software, firmware, and/or hardware described in this manual are the property of CyberData Corporation, provided under the terms of an agreement between CyberData Corporation and recipient of this manual, and their use is subject to that agreement and its terms.

DISCLAIMER: Except as expressly and specifically stated in a written agreement executed by CyberData Corporation, CyberData Corporation makes no representation or warranty, express or implied, including any warranty or merchantability or fitness for any purpose, with respect to this manual or the products, software, firmware, and/or hardware described herein, and CyberData Corporation assumes no liability for damages or claims resulting from any use of this manual or such products, software, firmware, and/or hardware. CyberData Corporation reserves the right to make changes, without notice, to this manual and to any such product, software, firmware, and/or hardware.

OPEN SOURCE STATEMENT: Certain software components included in CyberData products are subject to the GNU General Public License (GPL) and Lesser GNU General Public License (LGPL) "open source" or "free software" licenses. Some of this Open Source Software may be owned by third parties. Open Source Software is not subject to the terms and conditions of the CyberData COPYRIGHT NOTICE or software licenses. Your right to copy, modify, and distribute any Open Source Software is determined by the terms of the GPL, LGPL, or third party, according to who licenses that software.

Software or firmware developed by CyberData that is unrelated to Open Source Software is copyrighted by CyberData, subject to the terms of CyberData licenses, and may not be copied, modified, reverse-engineered, or otherwise altered without explicit written permission from CyberData Corporation.

TRADEMARK NOTICE: CyberData Corporation and the CyberData Corporation logos are trademarks of CyberData Corporation. Other product names, trademarks, and service marks may be the trademarks or registered trademarks of their respective owners.



Phone: (831) 373-2601
Technical Support Ext. 333
support@cyberdata.net
Fax: (831) 373-4193
Company and product information at www.cyberdata.net



Revision Information

Revision 930324D, released on 12-15-2010, corresponds to firmware version 1.1.2 and has the following changes:



- Updates [Figure 1-2, "Typical Installation"](#).
- Updates [Figure 2-7, "Relay or Strobe Alert Connection"](#).
- Updates [Figure 2-7, "Relay or Strobe Alert Connection"](#).
- Updates [Figure 2-9, "Line Out Connection"](#).
- Updates [Figure 2-10, "Speaker Out Connection"](#).

Important Safety Instructions

1. Read these instructions.
2. Keep these instructions.
3. Heed all warnings.
4. Follow all instructions.
5. Do not use this apparatus near water.
6. Clean only with dry cloth.
7. Do not block any ventilation openings. Install in accordance with the manufacturer's instructions.
8. Do not install near any heat sources such as radiators, heat registers, stoves, or other apparatus (including amplifiers) that produce heat.
9. Do not defeat the safety purpose of the polarized or grounding-type plug. A polarized plug has two blades with one wider than the other. A grounding type plug has two blades and a third grounding prong. The wide blade or the third prong are provided for your safety. If the provided plug does not fit into your outlet, consult an electrician for replacement of the obsolete outlet.
10. Protect the power cord from being walked on or pinched particularly at plugs, convenience receptacles, and the point where they exit from the apparatus.
11. Only use attachments/accessories specified by the manufacturer.
12. Refer all servicing to qualified service personnel. Servicing is required when the apparatus has been damaged in any way, such as power-supply cord or plug is damaged, liquid has been spilled or objects have fallen into the apparatus, the apparatus has been exposed to rain or moisture, does not operate normally, or has been dropped.
13. Prior to installation, consult local building and electrical code requirements.

| | |
|--|---|
|  <p>GENERAL ALERT</p> | <p>Warning <i>Electrical Hazard:</i> This product should be installed by a licensed electrician according to all local electrical and building codes.</p> |
|  <p>GENERAL ALERT</p> | <p>Warning <i>Electrical Hazard:</i> To prevent injury, this apparatus must be securely attached to the floor/wall in accordance with the installation instructions.</p> |

Pictorial Alert Icons

| | |
|--|---|
|  <p>GENERAL ALERT</p> | <p>General Alert</p> <p><i>This pictorial alert indicates a potentially hazardous situation. This alert will be followed by a hazard level heading and more specific information about the hazard.</i></p> |
|  | <p>Ground</p> <p><i>This pictorial alert indicates the Earth grounding connection point.</i></p> |

Hazard Levels

Danger: Indicates an imminently hazardous situation which, if not avoided, will result in death or serious injury. This is limited to the most extreme situations.

Warning: Indicates a potentially hazardous situation which, if not avoided, could result in death or serious injury.

Caution: Indicates a potentially hazardous situation which, if not avoided, could result in minor or moderate injury. It may also alert users against unsafe practices.

Notice: Indicates a statement of company policy (that is, a safety policy or protection of property).

The safety guidelines for the equipment in this manual do not purport to address all the safety issues of the equipment. It is the responsibility of the user to establish appropriate safety, ergonomic, and health practices and determine the applicability of regulatory limitations prior to use. Potential safety hazards are identified in this manual through the use of words *Danger*, *Warning*, and *Caution*, the specific hazard type, and pictorial alert icons.

Abbreviations and Terms

| Abbreviation or Term | Definition |
|----------------------|---|
| A-law | A standard companding algorithm, used in European digital communications systems to optimize, i.e., modify, the dynamic range of an analog signal for digitizing. |
| AVP | Audio Video Profile |
| Cat 5 | TIA/EIA-568-B Category 5 |
| DHCP | Dynamic Host Configuration Protocol |
| LAN | Local Area Network |
| LED | Light Emitting Diode |
| Mbps | Megabytes per Second. |
| NTP | Network Time Protocol |
| PBX | Private Branch Exchange |
| PoE | Power over Ethernet (as per IEEE 802.3af standard) |
| RTP | Real-time Transport Protocol |
| RTFM | Reset Test Function Management |
| SIP | Session Initiated Protocol |
| Talkback | Two-way communication enabled |
| TFTP | Trivial File Transfer Protocol |
| u-law | A companding algorithm, primarily used in the digital telecommunication |
| UC | Unified Communications |
| VoIP | Voice over Internet Protocol |

Contents

| | |
|---|-----------|
| Chapter 1 Product Overview | 1 |
| 1.1 How to Identify This Product | 1 |
| 1.2 Typical System Installation | 2 |
| 1.3 Product Features | 2 |
| 1.4 Supported Protocols | 3 |
| 1.5 Supported SIP Servers | 3 |
| 1.6 Product Specifications | 4 |
| Chapter 2 Installing the VoIP V2 Paging Amplifier | 5 |
| 2.1 Parts List | 5 |
| 2.2 Paging Amplifier Setup | 6 |
| 2.2.1 Paging Amplifier Components | 7 |
| 2.2.2 Paging Amplifier DIP Switches | 8 |
| 2.2.3 VoIP V2 Paging Amplifier System Installation and Connection Options | 9 |
| 2.2.4 Confirm Operation | 12 |
| 2.2.5 Confirm the IP Address and Test the Audio | 13 |
| 2.2.6 Adjust the Volume | 13 |
| 2.3 Configure the Paging Amplifier Parameters | 15 |
| 2.3.1 Paging Amplifier Web Page Navigation | 16 |
| 2.3.2 Log in to the Configuration Home Page | 17 |
| 2.3.3 Configure the Device Parameters | 20 |
| 2.3.4 Configure the Network Parameters | 23 |
| 2.3.5 Configure the SIP Parameters | 25 |
| 2.3.6 Configure the Night Ringer Parameters | 28 |
| 2.3.7 Configure the Sensor Configuration Parameters | 30 |
| 2.3.8 Configure the Multicast Configuration Parameters | 32 |
| 2.3.9 Configure the Audio Parameters | 36 |
| 2.3.10 User-created Audio Files | 39 |
| 2.3.11 Configure the Event Parameters | 41 |
| 2.3.12 Configure the Autoprovisioning Parameters | 46 |
| 2.3.13 Upgrade the Firmware and Reboot the Paging Amplifier | 51 |
| 2.3.14 Reboot the Paging Amplifier | 54 |
| Appendix A Mounting the Amplifier | 55 |
| A.1 Mount the Amplifier | 55 |
| Appendix B Setting up a TFTP Server | 56 |
| B.1 Set up a TFTP Server | 56 |
| B.1.1 In a LINUX Environment | 56 |
| B.1.2 In a Windows Environment | 56 |
| Appendix C Troubleshooting/Technical Support | 57 |
| C.1 Frequently Asked Questions (FAQ) | 57 |
| C.2 Documentation | 57 |
| C.3 Contact Information | 58 |
| C.4 Warranty | 58 |
| C.4.1 Warranty & RMA Returns within the United States | 59 |
| C.4.2 Warranty & RMA Returns Outside of the United States | 59 |
| C.4.3 Spare in the Air Policy | 59 |
| C.4.4 Return and Restocking Policy | 59 |
| C.4.5 Warranty and RMA Returns Page | 59 |
| Index | 60 |

1 Product Overview

The CyberData SIP-enabled VoIP V2 Paging Amplifier provides an easy method for implementing an IP-based overhead paging system for both new and legacy installations.

With up to 25 watts of driving power (802.3at), the Amplifier provides direct drive of a standard Horn speaker and supports a line-out connector for connection to an external amplifier. The interface is compatible with most SIP-based IP PBX servers that comply with the SIP RFC 3261. For non-SIP environments, the Paging Amplifier can be configured to listen to multicast address and port number combinations to form paging zones.

1.1 How to Identify This Product

To identify the VoIP V2 Paging Amplifier, look for a model number label similar to the one shown in [Figure 1-1](#). The model number on the label should be **011061**.

Figure 1-1. Model Number Label

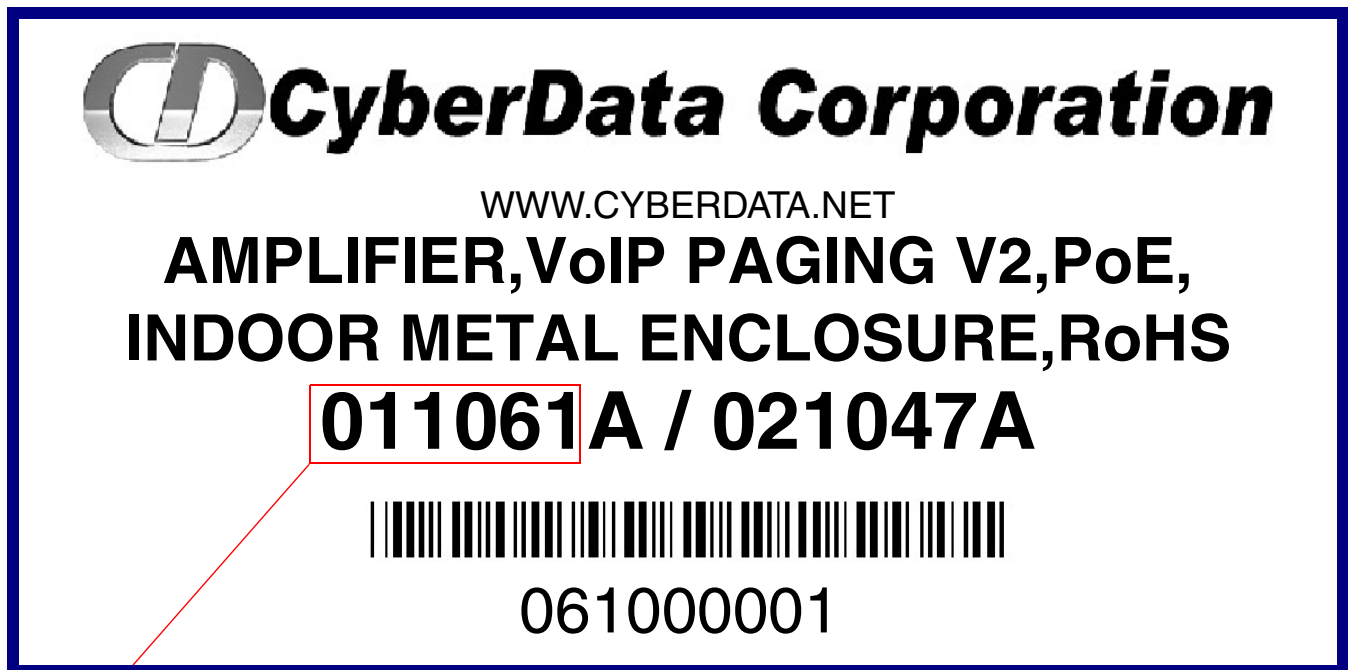

Model number

1.2 Typical System Installation

Figure 1-2 illustrates how the VoIP V2 Paging Amplifier is normally installed as part of a public address system.

Figure 1-2. Typical Installation

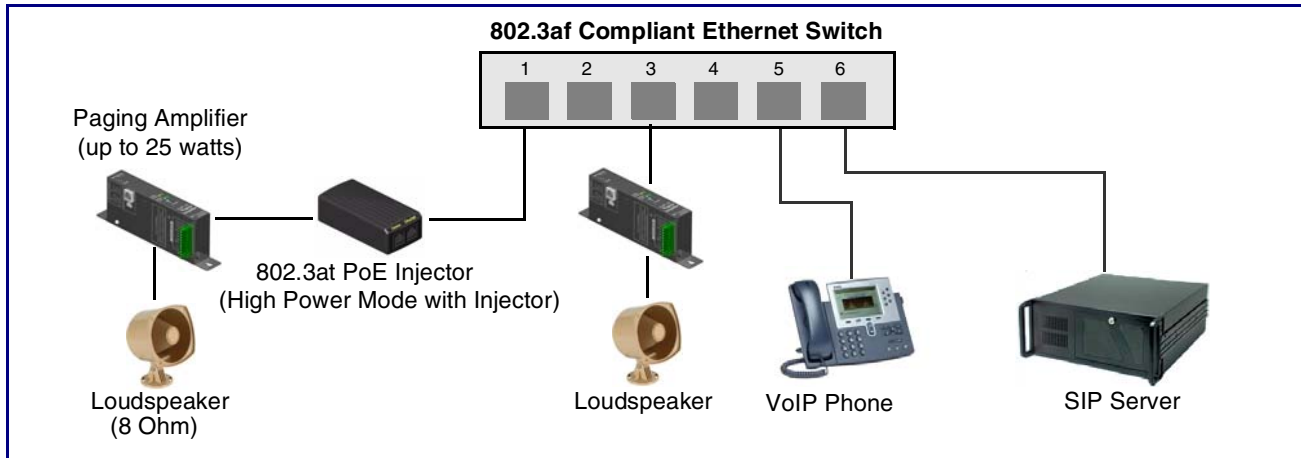

1.3 Product Features

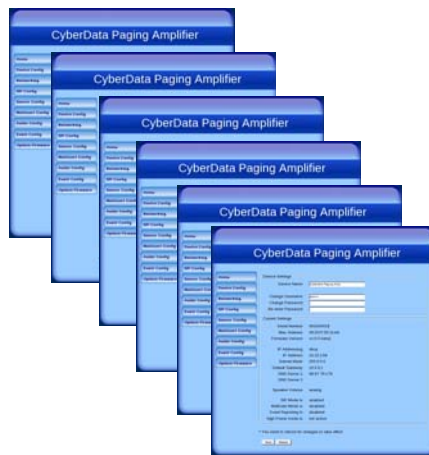

- SIP (RFC 3261) compatible
- Dual-speed ethernet 10/100 Mbps
- Web-based configuration
- Web-based firmware upgradeable
- PoE 802.3at and 802.3af-enabled
- IGMP
- Line-out connector
- DTMF controlled relay with open sense
- Direct speaker drive
- User-uploadable tones
- Simultaneous SIP and Multicast
- Autoprovisioning
- Line-In capability
- Nightringer

1.4 Supported Protocols

The V2 Paging Amplifier supports:

- SIP
- Multicast
- HTTP Web-based configuration

Provides an intuitive user interface for easy system configuration and verification of V2 Paging Amplifier operations.

- DHCP Client

Dynamically assigns IP addresses in addition to the option to use static addressing.

- TFTP Client

Facilitates Web-based firmware upgrades of the latest V2 Paging Amplifier capabilities.

- RTP
- RTP/AVP - Audio Video Profile
- SPEEX
- Audio Encodings

PCMU (G.711 mu-law)

PCMA (G.711 A-law)

Packet Time 20 ms

1.5 Supported SIP Servers

The following link contains information on how to configure the V2 Paging Amplifier for the supported SIP servers:

<http://www.cyberdata.net/support/server/index.html>

1.6 Product Specifications

Table 1. Product Specifications



| Category | Specification |
|---------------------------|---|
| Ethernet I/F | 10/100 Mbps |
| Power Input | PoE 802.3at or 802.3af |
| Operating Temperature | -30 to 55 C (-22 to 131 F) |
| Protocol | SIP RFC 3261 |
| Payload Types | G711, SPEEX |
| Regulatory Compliance | FCC Class A, CE |
| Warranty | 2 Years Limited |
| Dimensions | 1.26" x 9.45" x 3.13" |
| Audio Output | 802.3af - up to 10 Watts (default, 50% duty cycle [one second on and one second off]). 802.3at - up to 22 Watts (default, 50% duty cycle [one second on and one second off]) |
| Lineout: | |
| Output Signal Amplitudes | 2.0 VPP maximum |
| Output Level | +2dBm nominal |
| Total Harmonic Distortion | 0.5% maximum |
| Part Number | 011061 |

2 Installing the VoIP V2 Paging Amplifier

2.1 Parts List

Table 2-1 illustrates the parts for each Paging Amplifier and includes a kit for mounting.

Table 2-1. Parts List

| Quantity | Part Name | Illustration |
|----------|--|---|
| 1 | Paging Amplifier Assembly |  |
| 1 | Installation Quick Reference Guide |  |
| 1 | Paging Amplifier Mounting Accessory Kit, RoHS (part #071057A) which includes: (2) Plastic Ribbed Anchors (2) #6 Sheet Metal Screws |  |

2.2 Paging Amplifier Setup

Set up and configure each Paging Amplifier *before* you mount it.

CyberData delivers each Paging Amplifier with the factory default values indicated in [Table 2-2](#):

Table 2-2. Factory Default Settings—Default of Network

| Parameter | Factory Default Setting |
|------------------------------|-------------------------|
| IP Addressing | DHCP |
| IP Address ^a | 10.10.10.10 |
| Web Access Username | admin |
| Web Access Password | admin |
| Subnet Mask ^a | 255.0.0.0 |
| Default Gateway ^a | 10.0.0.1 |

a. Default if there is not a DHCP server present.

2.2.1 Paging Amplifier Components

Figure 2-3 shows the components of the Paging Amplifier .

Figure 2-3. Paging Amplifier Components

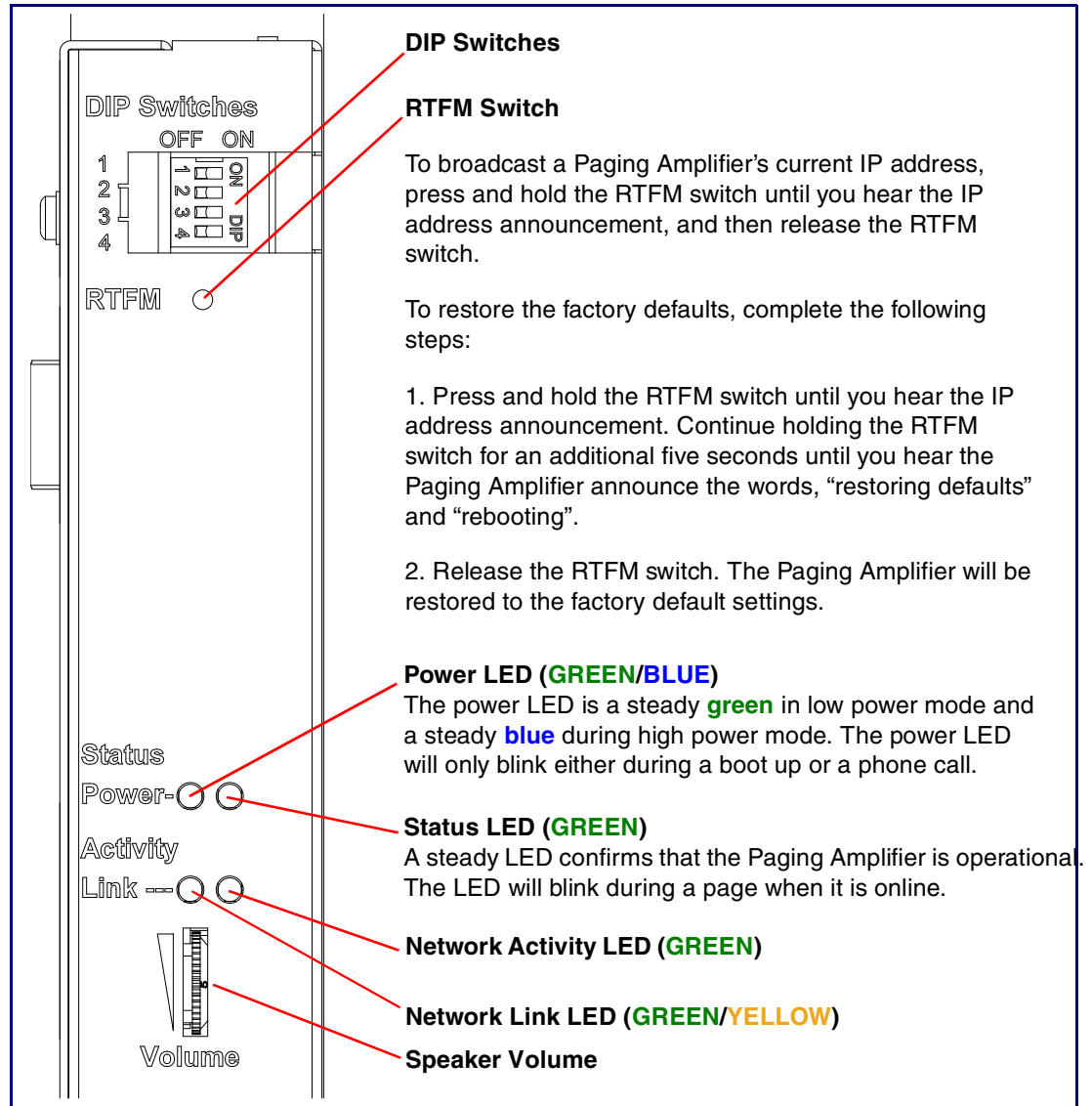

2.2.2 Paging Amplifier DIP Switches

See [Figure 2-4](#) to identify the DIP Switches.

Figure 2-4. DIP Switches

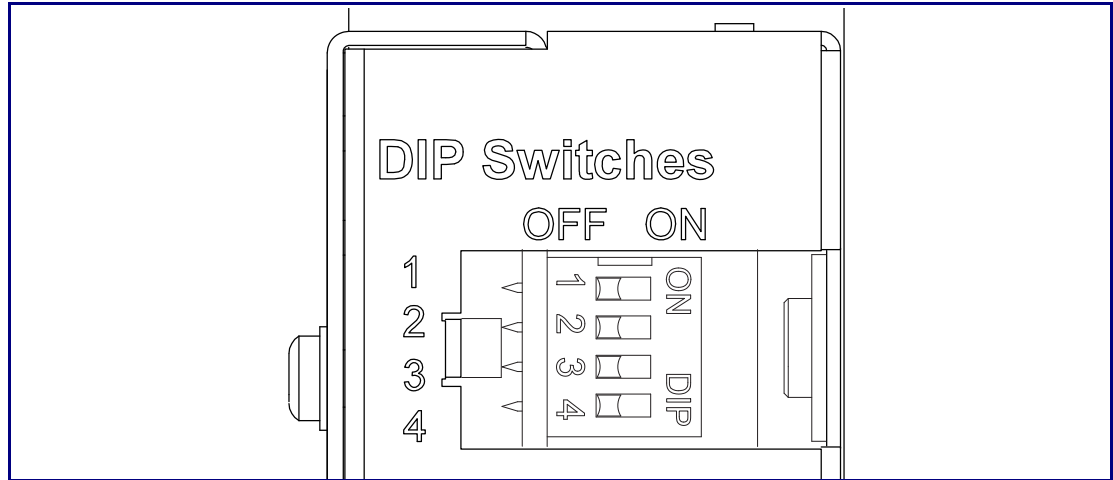

See [Table 2-3](#) and [Table 2-4](#) for the DIP Switch settings for the revision B (or later) board.

Table 2-3. DIP Switch Settings—Low Power—802.3af Compliant (Default)

| DIP Switch | Setting | Description |
|------------|---------|---|
| 1 | OFF | Sets PoE for 802.3af class. |
| 2 | N/A | Not applicable for power setting. |
| 3 | ON | Switch mode current set to LOW . |
| 4 | OFF | Low gain amplifier setting. |

Table 2-4. DIP Switch Settings—High Power—Non-PoE Compliant^a

| DIP Switch | Setting | Description |
|------------|---------|--|
| 1 | ON | Sets PoE for 802.3at class. |
| 2 | N/A | Not applicable for power setting. |
| 3 | OFF | Switch mode current set to HIGH . |
| 4 | ON | Force high gain amplifier. |

a. If set to high power, the unit will not power ON with 802.3af compliant switch. You must use a power injector in this mode (CyberData part number 010867A).

Table 2-5. DIP Switch 2 Settings

| DIP Switch | Setting | Description |
|------------|---------|---|
| 2 | OFF | Manual Vol. The speaker volume is set manually by the analog volume trimmer. |
| 2 | ON | Bypass. Bypasses the manual volume control of the analog volume trimmer and uses the web page volume settings. |

2.2.3 VoIP V2 Paging Amplifier System Installation and Connection Options

The following figures show the connection options for the VoIP V2 Paging Amplifier.

Figure 2-5. V2 Paging Amplifier Connections

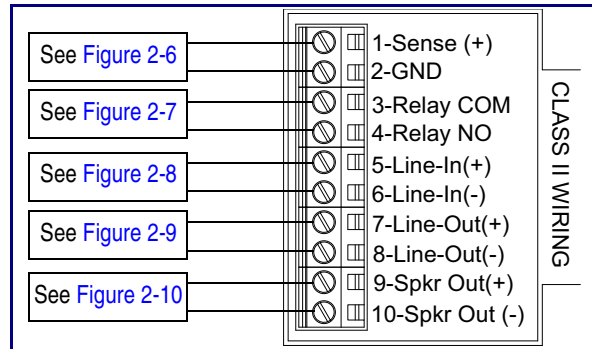

Figure 2-6. Sensor Connection

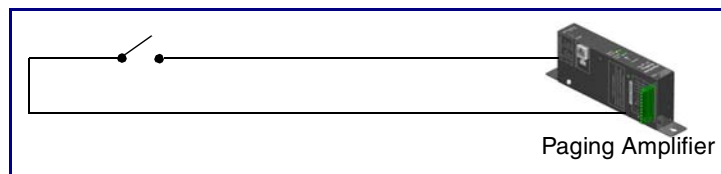

Figure 2-7. Relay or Strobe Alert Connection

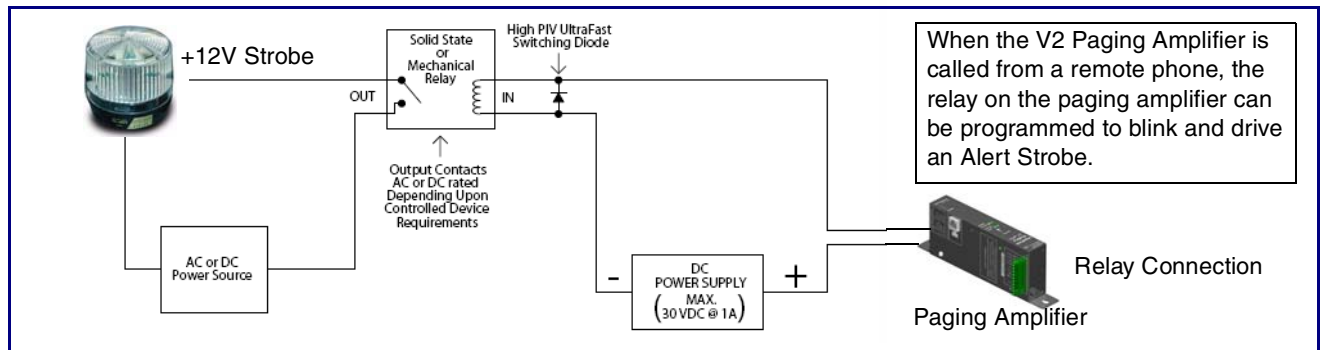

Figure 2-8. Line-In Connection

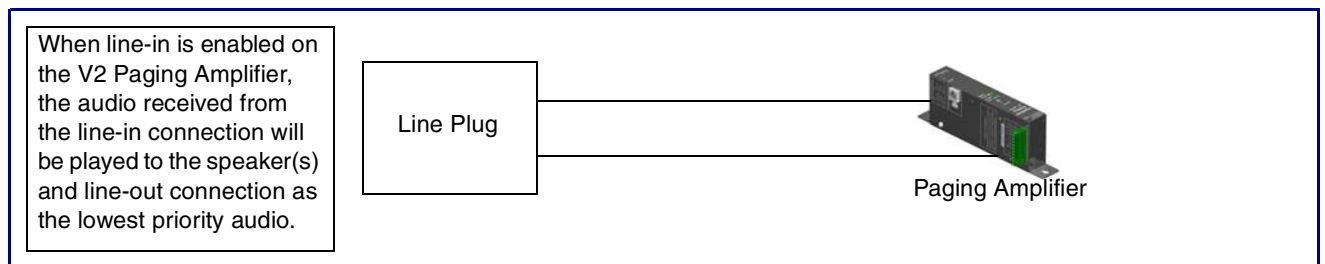

Figure 2-9. Line Out Connection

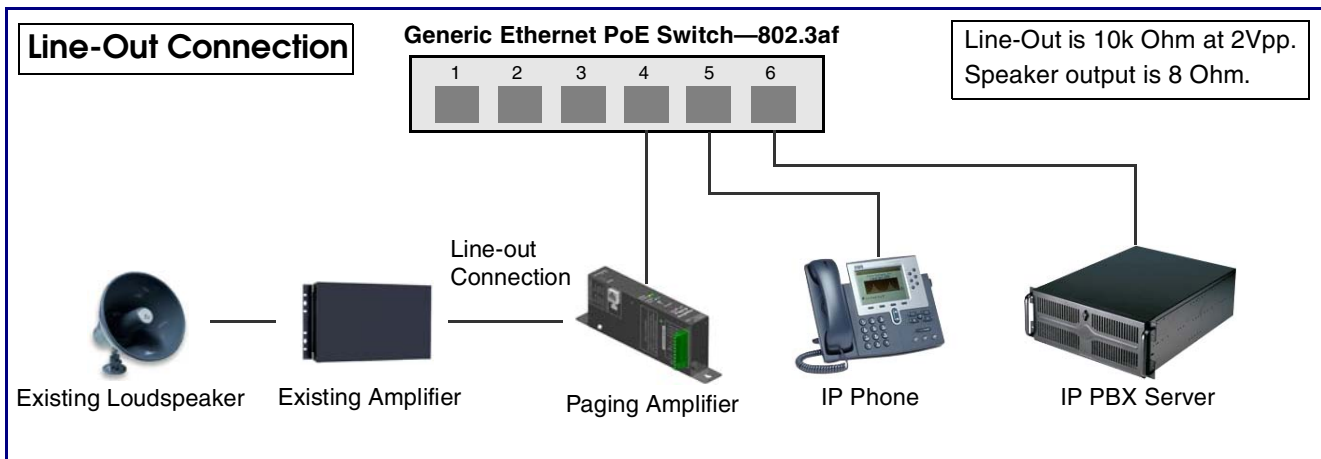
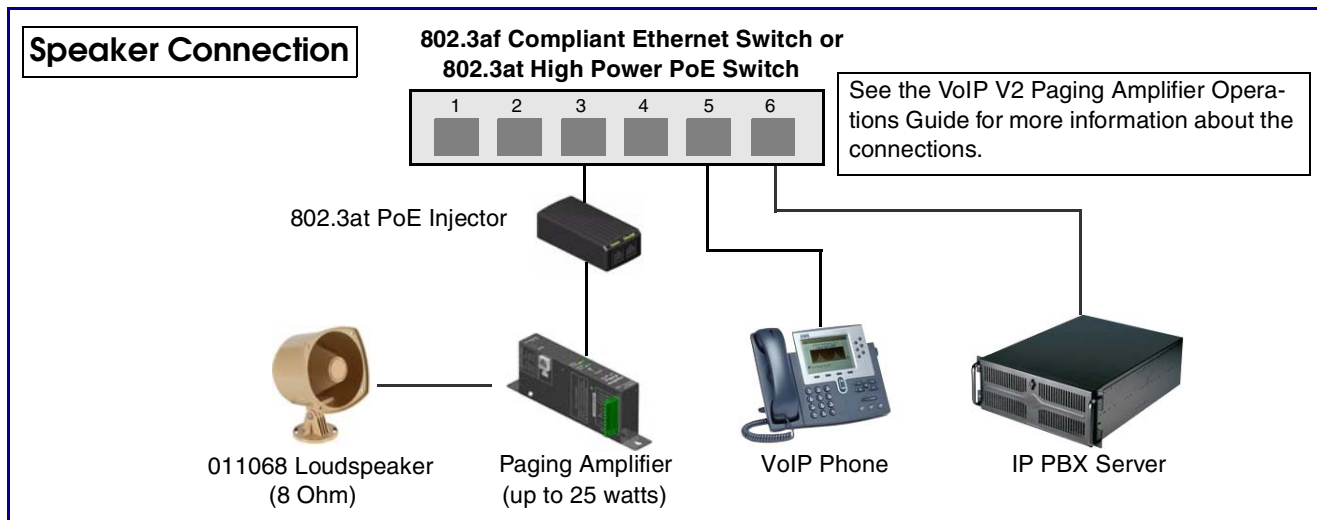

Figure 2-10. Speaker Out Connection



See [Table 2-6](#) for details about the Paging Amplifier connections.

Table 2-6. Paging Amplifier Connections

| Connection | Connection Details | Location |
|------------|--|--------------------------|
| Ethernet | <ul style="list-style-type: none"> Use a RJ 45 cable. | VoIP V2 Paging Amplifier |

2.2.3.1 Loudspeaker Type

Using the amplified output, the CyberData VoIP V2 Paging Amplifier supports the 011068 Loudspeaker or equivalent unamplified loudspeaker.

Figure 2-11. 011068 Loudspeaker



2.2.3.2 Cabling/Wiring

Using the amplified output, you may connect a 011068 loudspeaker or equivalent unamplified speaker to a Paging Amplifier with good quality speaker wire that is 16 gauge and limited to 25 feet in length.

2.2.4 Confirm Operation

After connecting the Paging Amplifier to the ethernet hub, use the LEDs on the Paging Amplifier face to confirm that the Paging Amplifier is operational and linked to the network.

Table 2-7. Paging Amplifier LEDs

| LED | Color | Function |
|----------|--------------|---|
| Power | Blue/Green | The power LED is illuminated a steady green when the power is on and in low power mode. The power LED is illuminated a steady blue when the amplifier is in high power mode. The power LED will blink during a boot up or a phone call. |
| Status | Green | After supplying power to the Paging Amplifier, a steady LED confirms that the Paging Amplifier is operational. The status LED will blink during a page when it is online. |
| Link | Green/Yellow | The Link LED is illuminated green for a 10Mb link or yellow/green for a 100Mb link when the network link to the Paging Amplifier is established. |
| Activity | Green | The Activity LED blinks to indicate network traffic. |

Figure 2-12. Paging Amplifier LEDs—Power and Link

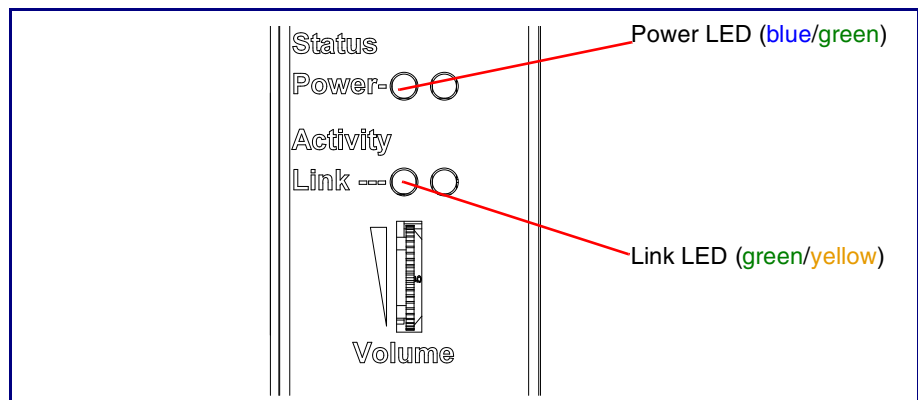
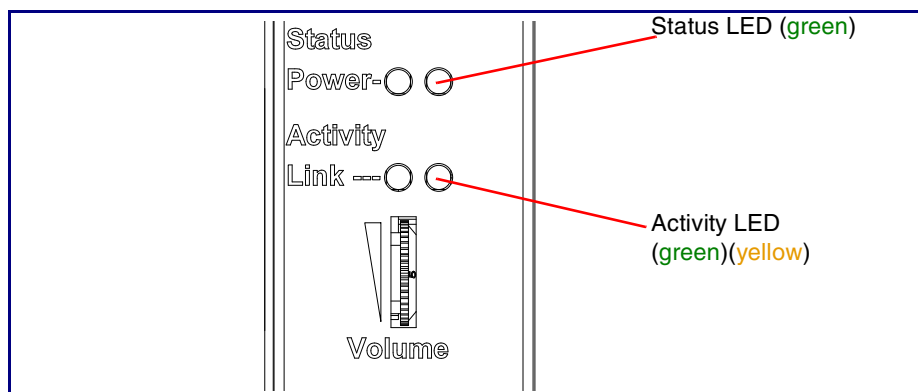

Figure 2-13. Paging Amplifier LEDs—Status and Activity



2.2.5 Confirm the IP Address and Test the Audio

2.2.5.1 RTFM Switch

When the Paging Amplifier is operational and linked to the network, use the Reset Test Function Management (RTFM) switch (Figure 2-14) on the Paging Amplifier face to announce and confirm the Paging Amplifier's IP Address, and test that the audio is working.

Figure 2-14. RTFM Switch

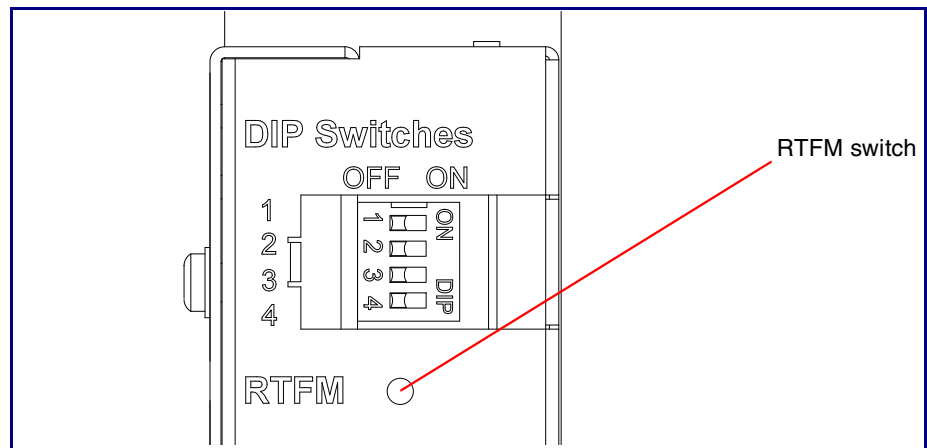

Announcing the IP Address To announce a Paging Amplifier's current IP address:

1. Press and hold the RTFM switch until you hear the IP address announcement.
2. Release the RTFM switch.



Caution

Equipment Caution: Pressing and holding the RTFM switch for more than five seconds after the IP address announcement will restore the V2 Paging Amplifier to the factory default settings. See the [“Restoring the Factory Default Settings”](#) section.

Restoring the Factory Default Settings

To restore the factory default settings, complete the following steps:

1. Press and hold the RTFM switch until you hear the IP address announcement. Continue holding the RTFM switch for an additional five seconds until you hear the Paging Amplifier announce the words, “restoring defaults” and “rebooting”.
2. Release the RTFM switch. The Paging Amplifier will be restored to the factory default settings.

2.2.6 Adjust the Volume

There are two ways to adjust the volume for the Paging Amplifier:

- The **Speaker Volume (0-9)** setting on the **Device Configuration** page
- The external **Volume** dial on the Paging Amplifier face

2.2.6.1 The “Speaker Volume (0-9)” Setting

To adjust the Paging Amplifier volume with the **Speaker Volume (0-9)** setting on the **Device Configuration** page, complete the following steps:

1. Make sure that dip switch 2 is set to **ON**.
2. Go to the Paging Amplifier **Home** page.
3. Select the **Device Configuration** page.
4. In the **Speaker Volume (0-9)** box, type a number between **0** (lowest) and **9** (highest).
5. Select **Save**.
6. Select **Reboot**.

2.2.6.2 The “Line-In Volume (0-9)” Setting

To adjust the Paging Amplifier volume with the **Line-In Volume (0-9)** setting on the **Device Configuration** page, complete the following steps:

1. Make sure that dip switch 2 is set to **ON**.
2. Go to the Paging Amplifier **Home** page.
3. Select the **Device Configuration** page.
4. In the **Line-In Volume (0-9)** box, type a number between **0** (lowest) and **9** (highest).
5. Select **Save**.
6. Select **Reboot**.

2.2.6.3 External Volume Dial

To adjust the Paging Amplifier volume with the external volume dial, complete the following steps:

1. Make sure that dip switch 2 is set to **OFF**.
2. Turn the external **Volume** dial (**Figure 2-15**) on the Paging Amplifier face.

Note For the lineout volume, the volume is fixed and the volume control is adjusted through an external amplifier.

Figure 2-15. External Volume Dial

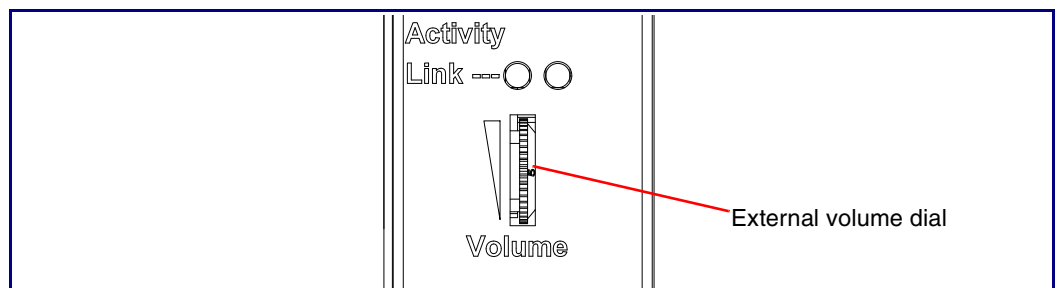

2.3 Configure the Paging Amplifier Parameters

To configure the Paging Amplifier online, use a standard web browser.

Configure each Paging Amplifier and verify its operation *before* you mount it. When you are ready to mount a Paging Amplifier enclosure, refer to [Appendix A, "Mounting the Amplifier"](#) for instructions.

All Paging Amplifier are initially configured with the default IP settings indicated in [Table 2-8](#).

When configuring more than one Paging Amplifier, attach the Paging Amplifiers to the network one at a time to avoid IP address conflicts.

Table 2-8. Factory Default Settings







| Parameter | Factory Default Setting |
|------------------------------|-------------------------|
| IP Addressing | DHCP |
| IP Address ^a | 10.10.10.10 |
| Web Access Username | admin |
| Web Access Password | admin |
| Subnet Mask ^a | 255.0.0.0 |
| Default Gateway ^a | 10.0.0.1 |

a. Default if there is not a DHCP server present.

2.3.1 Paging Amplifier Web Page Navigation

Table 2-9 shows the navigation buttons that you will see on every Paging Amplifier web page.

Table 2-9. V2 Paging Amplifier Web Page Navigation

| Web Page Item | Description |
|---|---|
|  | Link to the Home page. |
|  | Link to the Device Configuration page. |
|  | Link to the Networking page. |
|  | Link to the SIP Configuration page. |
|  | Link to the Nightringer page. |
|  | Link to the Sensor Configuration page. |
|  | Link to the Multicast Configuration page. |
|  | Link to the Audio Configuration page. |
|  | Link to the Event Configuration page. |
|  | Link to the Autoprovisioning Configuration page. |
|  | Link to the Update Firmware page. |

2.3.2 Log in to the Configuration Home Page

1. Open your browser to the Paging Amplifier IP address.

Note If the network does not have access to a DHCP server, the device will default to an IP address of 10.10.10.10.

Note Make sure that the PC is on the same IP network as the Paging Amplifier.

Note You may also download CyberData's VoIP Discovery Utility program which allows you to easily find and configure the default web address of the CyberData VoIP products.

CyberData's VoIP Discovery Utility program is available on the VoIP V2 Paging Amplifier product page at:

http://www.cyberdata.net/support/voip/discovery_utility.html

The Paging Amplifier ships in DHCP mode. To get to the **Home** page, use the discovery utility to scan for the device on the network and open your browser from there.

2. When prompted, use the following default **Web Access Username** and **Web Access Password** to access the **Home Page** (Figure 2-16):

Web Access Username: **admin**

Web Access Password: **admin**

Figure 2-16. Home Page

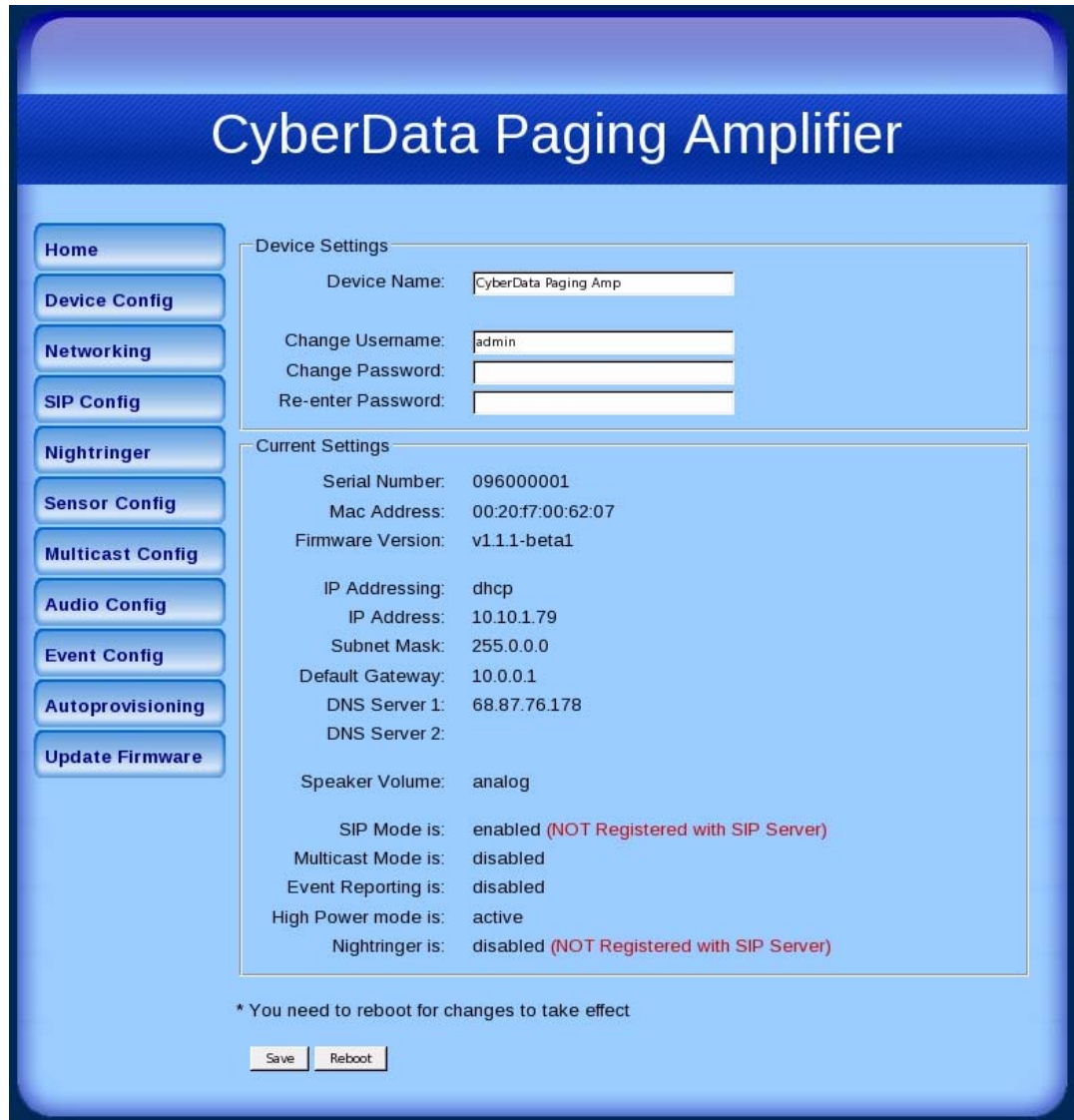

3. On the **Home Page**, review the setup details and navigation buttons described in [Table 2-10](#).

Table 2-10. Home Page Overview

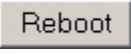
| Web Page Item | Description |
|---|--|
| Device Settings | |
| Device Name | Shows the device name (25 character limit). |
| Change Username | Type in this field to change the username (25 character limit). |
| Change Password | Type in this field to change the password (19 character limit). |
| Re-enter Password | Type the password again in this field to confirm the new password (19 character limit). |
| Current Settings | |
| Serial Number | Shows the device serial number. |
| Mac Address | Shows the device Mac address. |
| Firmware Version | Shows the current firmware version. |
| IP Addressing | Shows the current IP addressing setting (DHCP or Static). |
| IP Address | Shows the current IP address. |
| Subnet Mask | Shows the current subnet mask address. |
| Default Gateway | Shows the current default gateway address. |
| DNS Server 1 | Shows the current DNS Server 1 address. |
| DNS Server 2 | Shows the current DNS Server 2 address. |
| Speaker Volume | Shows the current Paging Amplifier volume mode: Digital (web page) or Analog (volume knob). |
| SIP Mode is | Shows the current status of the SIP Mode. |
| Multicast Mode is | Shows the current status of the Multicast Mode. |
| Event Reporting is | Shows the current status of the Event Reporting. |
| High Power Mode is | Shows the current status of the High Power Mode. |
| Nightringer is | Shows the current status of the Nightringer. |
|  | Click the Save button to save your configuration settings. Note: You need to reboot for changes to take effect. |
|  | Click on the Reboot button to reboot the system. |

2.3.3 Configure the Device Parameters

1. Click the **Device Configuration** button to open the **Device Configuration** page. See [Figure 2-17](#).

Figure 2-17. Device Configuration Page

CyberData Paging Amplifier

Device Configuration

Volume Settings

Speaker Volume: analog

Speaker Volume (0-9):

Line In Volume (0-9):

Relay Settings

Activate Relay with DTMF code:

DTMF Activation Code:

DTMF Activation Duration (in seconds):

Activate Relay During Ring:

Activate Relay During Night Ring:

Activate Relay While Call Active:

Miscellaneous Settings

Two Speakers Connected: Yes No

Beep on Initialization:

Auto-Answer Incoming Calls:

Play Ringback Tone:

Beep before Page:

Enable Line In:

* You need to reboot for changes to take effect

Save Test Audio Test Relay Reboot

2. On the **Device Configuration** page, you may enter values for the parameters indicated in [Table 2-11](#).

Table 2-11. Device Configuration Parameters

| Web Page Item | Description |
|---|---|
| Volume Settings | |
| Speaker Volume (0-9) | Type the desired Paging Amplifier volume level into this field (range is 0 - 9). |
| Line-In Volume (0-9) | Type the desired line-in volume level into this field (range is 0 - 9). |
| Relay Settings | |
| Activate Relay with DTMF Code | When selected, the relay can be activated with a DTMF code. |
| DTMF Activation Code | Type the desired DTMF activation code (25 character limit). |
| DTMF Activation Duration (in seconds) | Type the desired DTMF activation duration (in seconds) (1 character limit). |
| Activate Relay During Ring | When selected, the relay will be activated for as long as the phone is ringing. NOTE: When the phone is set to Auto Answer , it will not ring and this option does nothing. |
| Activate Relay During Night Ring | When selected, the relay will be activated for as long as a night ring tone is playing. NOTE: When the phone is set to Auto Answer , it will not ring and this option does nothing. |
| Activate Relay While Call Active | When selected, the relay will be activated for as long as the call is active. |
| Miscellaneous Settings | |
| Two Speakers Connected | Select Yes if two speakers are connected to the Paging Amplifier. Select No if two speakers are not connected to the Paging Amplifier. |
| Beep on Initialization | When selected, you will hear a beep when the Paging Amplifier initializes. |
| Auto-Answer Incoming Calls | When selected, the Paging Amplifier automatically answers incoming calls. |
| Play Ringback Tone | Check this box to enable the device to play a ringtone while the remote device is ringing. |
| Beep Before Page | Enable/Disable the tone (beep) before each page. |
| Enable Line In | When selected, whatever audio source that you have selected (mp3 player, internet stream, etc.) will be played. Note: The line in audio will be treated as low priority audio that will only play if there is no other audio playing. When higher priority audio is playing, the line in audio will be muted. |
|  | Click the Save button to save your configuration settings. Note: You need to reboot for changes to take effect. |

Table 2-11. Device Configuration Parameters (continued)

| Web Page Item | Description |
|---|---|
|  | Click on the Test Audio button to do an audio test. Generates a voice message for testing the device audio quality and volume. It plays the audio at the volume you have configured the paging amp for Note: If the test audio button is pressed while music is playing via the Enabled Line In feature, the music will be muted during the test audio message. |
|  | Click on the Test Relay button to do a relay test. |
|  | Click on the Reboot button to reboot the system. |

3. After changing the parameters, click the **Save** button.

2.3.4 Configure the Network Parameters

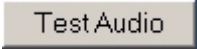
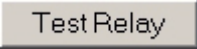
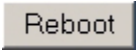
1. Click the **Networking** button to open the **Network Configuration** page (Figure 2-18).

Figure 2-18. Network Configuration Page

CyberData Paging Amplifier

Home **Device Config** **Networking** **SIP Config** **Nightringer** **Sensor Config** **Multicast Config** **Audio Config** **Event Config** **Autoprovisioning** **Update Firmware**

Network Configuration

Stored Network Settings

IP Addressing: Static DHCP

IP Address: 10.10.10.10

Subnet Mask: 255.0.0.0

Default Gateway: 10.0.0.1

DNS Server 1: 10.0.0.1

DNS Server 2:

Current Network Settings

IP Address: 10.10.1.79

Subnet Mask: 255.0.0.0

Default Gateway: 10.0.0.1

DNS Server 1: 68.87.76.178

DNS Server 2:

* You need to reboot for changes to take effect

Save Reboot

2. On the **Network Configuration** page, enter values for the parameters indicated in [Table 2-12](#).

Table 2-12. Network Configuration Parameters

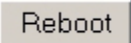
| Web Page Item | Description |
|---|---|
| Network Settings | |
| IP Addressing* | Select either DHCP IP Addressing or Static IP Addressing by marking the appropriate radio button. If you select Static , configure the remaining parameters indicated in Table 2-12 . If you select DHCP , go to Step 3 . |
| IP Address* | Enter the Static IP address. |
| Subnet Mask | Enter the Subnet Mask address. |
| Default Gateway | Enter the Default Gateway address. |
| DNS Server 1* | Enter the DNS Server 1 address. |
| DNS Server 2* | Enter the DNS Server 2 address. |
| Current Network Settings | |
| IP Address | Shows the current Static IP address. |
| Subnet Mask | Shows the current Subnet Mask address. |
| Default Gateway | Shows the current Default Gateway address. |
| DNS Server 1 | Shows the current DNS Server 1 address. |
| DNS Server 2 | Shows the current DNS Server 2 address. |
|  | Click the Save button to save your configuration settings. Note: You need to reboot for changes to take effect. |
|  | Click on the Reboot button to reboot the system. |

3. After changing the parameters, click **Save Settings**. This updates the changed parameters and reboots the Paging Amplifier if appropriate.
4. Connect the Paging Amplifier to the target network.
5. From a system on the same network as the Paging Amplifier, open a browser with the new IP address of the Paging Amplifier.

2.3.5 Configure the SIP Parameters

1. Click **SIP Config** to open the **SIP Configuration** page (Figure 2-19).

Note For specific server configurations, go to the **IP-PBX Server Compatibility** page at:

<http://www.cyberdata.net/support/server/index.html>

Figure 2-19. SIP Configuration Page

2. On the **SIP Configuration** page, you may enter values for the parameters indicated in Table 2-13.

Table 2-13. SIP Configuration Parameters

| Web Page Item | Description |
|----------------------|------------------------------------|
| Enable SIP Operation | Enables or disables SIP operation. |

Table 2-13. SIP Configuration Parameters (continued)

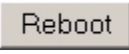
| Web Page Item | Description |
|---|--|
| SIP Settings | |
| SIP Server* | Type the SIP server represented as either a numeric IP address in dotted decimal notation or the fully qualified host name (64 character limit [FQDN]). |
| Remote SIP Port* | Type the Remote SIP Port number (default 5060) (0 - 65535). |
| Local SIP Port* | Type the Local SIP Port number (default 5060) (0 - 65535). |
| Outbound Proxy | Type the Outbound Proxy as either a numeric IP address in dotted decimal notation or the fully qualified host name (64 character limit [FQDN]). |
| Outbound Proxy Port | Type the Outbound Proxy Port number (0 - 65535). |
| SIP User ID* | Type the SIP User ID (up to 25 alphanumeric characters). |
| Authenticate ID* | Type the Authenticate ID (up to 25 alphanumeric characters). |
| Authenticate Password* | Type the Authenticate Password (up to 25 alphanumeric characters). |
| Register with a SIP Server* | Enable or disable SIP Registration. |
| Re-registration Interval (in seconds)* | Type the SIP Registration lease time in seconds (default is 120 seconds) (range is 100 - ?). |
| Unregister on Reboot* | <ul style="list-style-type: none"> • When selected, the Paging Amplifier automatically unregisters when it is rebooted. • When not selected, the Paging Amplifier remains registered when it is rebooted. |
| Buffer SIP Calls | When this is enabled, SIP calls to the speaker will be stored in memory and will play when either the call is terminated or the buffer is full. The receive buffer is 2MB in size and this is equal to about four minutes of ulaw encoded audio. |
| RTP Settings | |
| RTP Port (even) | <p>Specify the port number used for the RTP stream after establishing a SIP call. The RTP port has to be an even number between 0 and 65534. This port can be programmed for people who are not working on a local LAN, but who want to have outside access. Instead of RTP port being a random port, it will be set up so that only two ports can be opened in a firewall.</p> <p>Note: The RTP port number has to be an even number because the control port is always one port number higher. Therefore, audio will go through the port number that you enter into the RTP port field, but the RTP control signals will go through a port that is one number higher than the RTP port field.</p> |
|  | <p>Click the Save button to save your configuration settings.</p> <p>Note: You need to reboot for changes to take effect.</p> |
|  | Click on the Reboot button to reboot the system. |

3. After changing the parameters, click **Save Settings**.

2.3.5.1 Point-to-Point Configuration

When the board is set to not register with a SIP server, it's possible to set the device to dial out to a single endpoint. To do this, do the following:

1. On the **SIP Configuration** page (Figure 2-20), make sure that the **Register with a SIP Server** parameter is not selected.
2. Type the IP address of the remote device that you want to contact into the **Dial out Extension** field

Note The delayed DTMF functionality is available in the Point-to-Point Mode.

Note Establishing point-to-point SiP calls may not work with all phones.

Figure 2-20. SIP Configuration Page Set to Point-to-Point Mode

Home SIP Configuration

Device Config Enable SIP operation: (NOT Registered with SIP Server)

Networking SIP Settings

SIP Config SIP Server: 10.0.0.253

Nightringer Remote SIP Port: 5060

Sensor Config Local SIP Port: 5060

Multicast Config Outbound Proxy:

Audio Config Outbound Proxy Port:

Event Config SIP User ID: 199

Autoprovisioning Authenticate ID: 199

Update Firmware Authenticate Password: ext199

Register with a SIP Server:

Re-registration Interval (in seconds): 120

Unregister on Reboot:

Buffer SIP Calls:

RTP Settings

RTP Port (even): 10500

* You need to reboot for changes to take effect

Save Reboot

Speaker is set to **NOT** register with a SIP server

2.3.6 Configure the Night Ringer Parameters

1. Click on the **Nightringer** button to open the **Nightringer Configuration** page. See [Figure 2-23](#).



Figure 2-21. Nightringer Configuration Setup

The screenshot shows the 'Nightringer Configuration' page of the CyberData Paging Amplifier. The page has a blue header with the title 'CyberData Paging Amplifier'. On the left side, there is a vertical menu with buttons for 'Home', 'Device Config', 'Networking', 'SIP Config', 'Nightringer', 'Sensor Config', 'Multicast Config', 'Audio Config', 'Event Config', 'Autoprovisioning', and 'Update Firmware'. The 'Nightringer' button is highlighted. The main content area is titled 'Nightringer Configuration' and contains the following elements:

- 'Enable Nightringer: (NOT Registered with SIP Server)'
- A box labeled 'Nightringer Settings' containing:
 - 'SIP Server: [text input]'
 - 'Remote SIP Port: [text input with value 0]'
 - 'Local SIP Port: [text input with value 0]'
 - 'User ID: [text input]'
 - 'Authenticate ID: [text input]'
 - 'Authenticate Password: [text input]'
 - 'Re-registration Interval (in seconds): [text input with value 0]'
- A note: '* You need to reboot for changes to take effect'
- 'Save' and 'Reboot' buttons at the bottom.

- On the **Nightringer Configuration** page, enter values for the parameters indicated in [Table 2-16](#).

Table 2-14. Nightringer Configuration Parameters

| Web Page Item | Description |
|---|--|
| Enable Nightringer | When the nightringer is enabled, the device will attempt to register a second extension with the SIP server. Any calls made to this extension will play a ringtone. |
| Nightringer Settings | |
| SIP Server | Type the SIP server represented as either a numeric IP address in dotted decimal notation. |
| Remote SIP Port | Type the Remote SIP Port number (default 5060) (8 character limit). |
| Local SIP Port | Type the Local SIP Port number (default 5060) (8 character limit). Note: This value cannot be the same as the Local SIP Port* found on the SIP Configuration Page . |
| User ID | Type the User ID (up to 64 alphanumeric characters). |
| Authenticate ID | Type the Authenticate ID (up to 64 alphanumeric characters). |
| Authenticate Password | Type the Authenticate Password (up to 64 alphanumeric characters). |
| Re-registration Interval (in seconds)* | Type the SIP Registration lease time in minutes (default is 60 minutes) (8 character limit). Re-registration Interval (in seconds)* |
|  | Click the Save button to save your configuration settings. Note: You need to reboot for changes to take effect. |
|  | Click on the Reboot button to reboot the system. |

- After changing the parameters, click on the **Save** button.

2.3.7 Configure the Sensor Configuration Parameters

The sensor (pins 1 and 2) on the header can be used to monitor something's open or closed state. There is an option on the **Sensor Configuration** page to trigger on an open or short condition on these pins.

For the sensor there are three actions that the Paging Amplifier can do:

- Activate the relay until the sensor is deactivated
- Loop an audio file until the sensor is deactivated
- Call a preset extension and play a pre-recorded audio file (loops until user hangs up)

Note Calling a preset extension can be set up as a point-to-point call, but currently can't send delayed DTMF tones.

1. Click **Sensor Config** to open the **Sensor Configuration** page (Figure 2-22).

Figure 2-22. Sensor Configuration Page

CyberData Paging Amplifier

Sensor Configuration

Home
Device Config
Networking
SIP Config
Nightringer
Sensor Config
Multicast Config
Audio Config
Event Config
Autoprovisioning
Update Firmware

Sensor Settings

Sensor Normally Closed: Yes No

Activate Relay:

Play Audio Locally:

Play Audio Remotely:

Dial Out Extension: 204



Test Sensor

* You need to reboot for changes to take effect

Save Reboot

2. On the **Sensor Configuration** page, enter values for the parameters indicated in [Table 2-15](#).

Table 2-15. Sensor Configuration Parameters

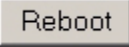
| Web Page Item | Description |
|---|--|
| Sensor Settings | |
| Sensor Normally Closed | Select the inactive state of the sensors. |
| Activate Relay | Check this box to activate the relay until the sensor is deactivated. |
| Play Audio Locally | Check this box to loop an audio file until the sensor is deactivated. |
| Play Audio Remotely | Check this box to make only one call to a preset extension and play a pre-recorded audio file repeatedly. |
| Dial Out Extension | Enter the dial-out extension number. |
|  | Use this button to test the sensor. |
|  | Click the Save button to save your configuration settings. Note: You need to reboot for changes to take effect. |
|  | Click on the Reboot button to reboot the system. |

3. After changing the parameters, click **Save Settings**.

2.3.8 Configure the Multicast Configuration Parameters

Multicast groups use multicasting to create public address paging zones. Multicasting is based on the concept of a group. Multicast addresses specify an arbitrary group of IP hosts that have joined the group and want to receive traffic sent to the group. Group members send IGMP messages to their local multicast routers, allowing the group traffic traversal from the source.

Multicast configuration provides the ability to join up to 10 paging zones. A paging zone can consist of one, or many, CyberData multicast group-enabled Paging Amplifiers. There is no limit to how many Paging Amplifiers can be in a given paging zone. Each multicast group is defined by a multicast address and port number. Each multicast group is also assigned a priority, allowing simultaneously arriving pages to be serviced based on importance. Multicast groups are compatible with IGMP through version 3.

Note The Paging Amplifier supports simultaneous SIP and Multicast.

1. Click on the **Multicast Configuration** button to open the **Multicast Configuration** page. See [Figure 2-23](#).

Figure 2-23. Multicast Configuration Setup

CyberData Paging Amplifier

Multicast Configuration

Enable Multicast operation:

Device Settings

| priority | Address | port | Multicast Group Name | Buffered |
|---------------------------------------|--------------|-------|----------------------|-------------------------------------|
| 9 | 239.168.3.10 | 11000 | Emergency | <input type="checkbox"/> |
| 8 | 239.168.3.9 | 10000 | MG8 | <input type="checkbox"/> |
| 7 | 239.168.3.8 | 9000 | MG7 | <input type="checkbox"/> |
| 6 | 239.168.3.7 | 8000 | MG6 | <input type="checkbox"/> |
| 5 | 239.168.3.6 | 7000 | MG5 | <input type="checkbox"/> |
| SIP calls are considered priority 4.5 | | | | |
| 4 | 239.168.3.5 | 6000 | MG4 | <input type="checkbox"/> |
| 3 | 239.168.3.4 | 5000 | MG3 | <input type="checkbox"/> |
| 2 | 239.168.3.3 | 4000 | MG2 | <input checked="" type="checkbox"/> |
| 1 | 239.168.3.2 | 3000 | MG1 | <input type="checkbox"/> |
| 0 | 239.168.3.1 | 2000 | Background Music | <input type="checkbox"/> |



Line In audio is the lowest priority.

Ports must be even numbers in the range 2000-65535
Priority 9 is the highest and 0 is the lowest
A higher priority audio stream will always supercede a lower one
Priority 9 streams will play at maximum volume

* You need to reboot for changes to take effect

2. On the **Multicast Configuration** page, enter values for the parameters indicated in [Table 2-16](#).

Table 2-16. Multicast Configuration Parameters

| Web Page Item | Description |
|---|--|
| Enable Multicast Operation | Enables or disables multicast operation. |
| Device Settings | |
| Priority | Indicates the priority for the multicast group. Priority 9 is the highest (emergency streams). 0 is the lowest (background music). See Section 2.3.8.1, "Assigning Priority" for more details. |
| Address | Enter the multicast IP Address for this multicast group (15 character limit). |
| Port (range can be from 2000 to 65535) | Enter the port number for this multicast group (5 character limit). Note: The multicast ports have to be even values. The webpage will enforce this restriction. |
| Multicast Group Name | Assign a descriptive name for this multicast group (25 character limit). |
| Buffered | When buffering is enabled for a multicast stream, it will store any audio received on this socket to memory and play it back when the stream is stopped or the buffer is full. |
|  | Click the Save button to save your configuration settings. Note: You need to reboot for changes to take effect. |
|  | Click on the Reboot button to reboot the system. |

3. After changing the parameters, click on the **Save** button.

2.3.8.1 Assigning Priority

When playing multicast streams, audio on different streams will preempt each other according to their priority in the list. An audio stream with a higher priority will interrupt a stream with a lower priority.

If both SIP and Multicast is enabled, SIP audio streams are considered priority 4.5. SIP audio will interrupt multicast streams with priority 0 through 4 and will be interrupted by multicast streams with priority 5 through 9.

During priority 9 multicast streams, the analog volume control is bypassed and the volume level is set to maximum.

Line In audio is considered the lowest priority, so it will be muted if there are any multicast or SIP audio streams playing.

For example, if the test audio button on the Device Config page is pressed while music is playing via the Enabled Line In feature, the music will be muted during the test audio message.

Note SIP calls, buffered SIP calls, multicast streams, buffered multicast streams, ring tones, ringback tones, and nightring tones are all prioritized.

Ringtones and Nightringtones

Ringtones all play at the same priority level. This means that it is possible to have a nightring tone and a normal ringtone playing at the same time.

The maximum ringtone duration is 2,097,152 bytes or about four minutes of ulaw audio.

Lengthy Pages

Concerning how lengthy pages are handled (where someone puts the phone down for 15 minutes), after the 2MB limit is reached, further data will be thrown away while the audio file is played back. When the file is done playing, it will stop throwing away input and begin buffering data for another four minutes.

Therefore, with the buffered mode enabled on a stream playing background music, you will hear the following sequence of events:

1. Four minutes of silence.
2. Music from 0:00 through 4:00.
3. Four minutes of silence.
4. Music from 8:00 through 12:00 and so on.

Buffered Audio

When the device is playing back buffered audio and this buffered audio is interrupted by a higher priority stream, once the higher priority streams is finished, the device will restart the lower priority stream from the beginning.

2.3.9 Configure the Audio Parameters

Click the **Audio Config** button to open the **Audio Configuration** page. The **Audio Configuration** page is used to add custom audio to the board. User uploaded audio will take precedence over the audio files shipped with the Paging Amplifier.

Figure 2-24. Audio Configuration Page

| Audio File | Radio Button |
|-------------------------------------|-----------------------|
| 0: default | <input type="radio"/> |
| 1: default | <input type="radio"/> |
| 2: default | <input type="radio"/> |
| 3: default | <input type="radio"/> |
| 4: default | <input type="radio"/> |
| 5: default | <input type="radio"/> |
| 6: default | <input type="radio"/> |
| 7: default | <input type="radio"/> |
| 8: default | <input type="radio"/> |
| 9: default | <input type="radio"/> |
| Dot: default | <input type="radio"/> |
| Audiotest: default | <input type="radio"/> |
| Pagetone: default | <input type="radio"/> |
| Your IP Address is: default | <input type="radio"/> |
| Rebooting: default | <input type="radio"/> |
| Restoring Default: default | <input type="radio"/> |
| Ringback Tone: 2k_2v.wav | <input type="radio"/> |
| Ring Tone: default | <input type="radio"/> |
| Sensor Triggered: default | <input type="radio"/> |
| Night Ring Tone: Victoria_Falls.wav | <input type="radio"/> |

Server

tftp server ip address:

Available Space = 12.61MB

On the **Audio Configuration** page, enter values for the parameters indicated in [Table 2-17](#).

Note Each entry on the **Audio Configuration** page replaces one of the stock audio files on the board. When the input box displays the word **default**, the Paging Amplifier is using the stock audio file. If that file is replaced with a user file, it will display the uploaded filename.

Table 2-17. Audio Configuration Parameters

| Web Page Item | Description |
|--|---|
| Audio Files | |
| Radio button (to the right of each input box) | <p>For each entry, if the user selects the radio button to the right of the input box they have several options:</p> <p>The Test Audio button will play that audio file.</p> <p>The Restore Default button will delete any user uploaded audio and restore the stock audio file.</p> <p>The Download button will download a new user audio file to the board. It will delete any pre-existing user uploaded audio files.</p> |
| 0-9 | <p>The name of the audio configuration option is the same as the spoken audio that plays on the board (24 character limit).</p> <p>'0' corresponds to the spoken word "zero." '1' corresponds to the spoken word "one." '2' corresponds to the spoken word "two." '3' corresponds to the spoken word "three." '4' corresponds to the spoken word "four." '5' corresponds to the spoken word "five." '6' corresponds to the spoken word "six." '7' corresponds to the spoken word "seven." '8' corresponds to the spoken word "eight." '9' corresponds to the spoken word "nine."</p> |
| Dot | Corresponds to the spoken word "dot." (24 character limit) |
| Audiotest | Corresponds to the audio message "This is the CyberData IP speaker test message..." (24 character limit) |
| Pagetone | Corresponds to a simple tone that is unused by default (24 character limit). |
| Your IP Address is | Corresponds to the message "Your IP address is..." (24 character limit). |
| Rebooting | Corresponds to the spoken word "Rebooting" (24 character limit). |
| Restoring default | Corresponds to the message "Restoring default" (24 character limit). |
| Ringback Tone | This is the ringback tone that plays when calling a remote extension (24 character limit). |
| Ring Tone | This is the tone that plays when set to ring when receiving a call (24 character limit). |
| Sensor Triggered | This is the audio that plays when the sensor is triggered (24 character limit). |
| Night Ring Tone | Specifies the ringtone for nightring. By default this parameter uses the same audio file that is selected for the Ring Tone parameter. |

Table 2-17. Audio Configuration Parameters (continued)

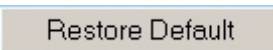
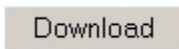
| Web Page Item | Description |
|---|---|
| Server | |
| TFTP Server IP address | Enter the IP address of your TFTP server into the TFTP Server IP parameter field (15 character limit). |
| Available Space = | Indicates how much space is left in the internal non-volatile memory. |
|  | Click on the Test Audio button to test the audio. Note: If the test audio button on the Device Config page is pressed while music is playing via the Enabled Line In feature, the music will be muted during the test audio message. |
|  | Click on the Restore Default button to restore the default settings. |
|  | Click on the Download button to download a file from a TFTP server at the address specified on the Update Firmware page. Note: Downloading large files can sometimes take a long time. It's not recommended to interrupt the process once it has started. |

2.3.10 User-created Audio Files

User created audio files should be saved in the following format:

RIFF (little-endian) data, WAVE audio, Microsoft PCM, 16 bit, mono 8000 Hz

You can use the free utility *Audacity* to convert audio files into this format. See [Figure 2-25](#) through [Figure 2-27](#).

Figure 2-25. Audacity 1

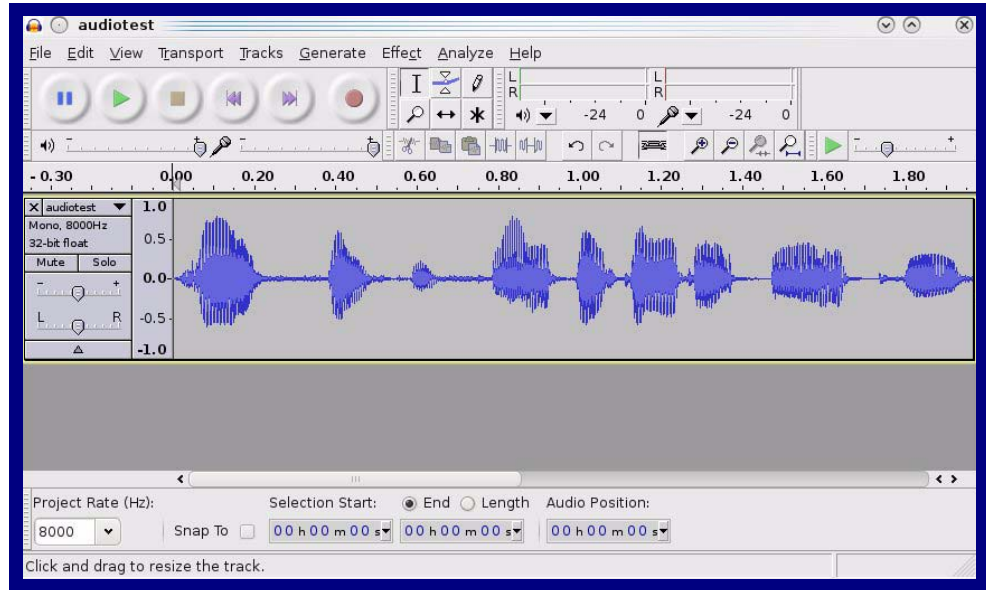
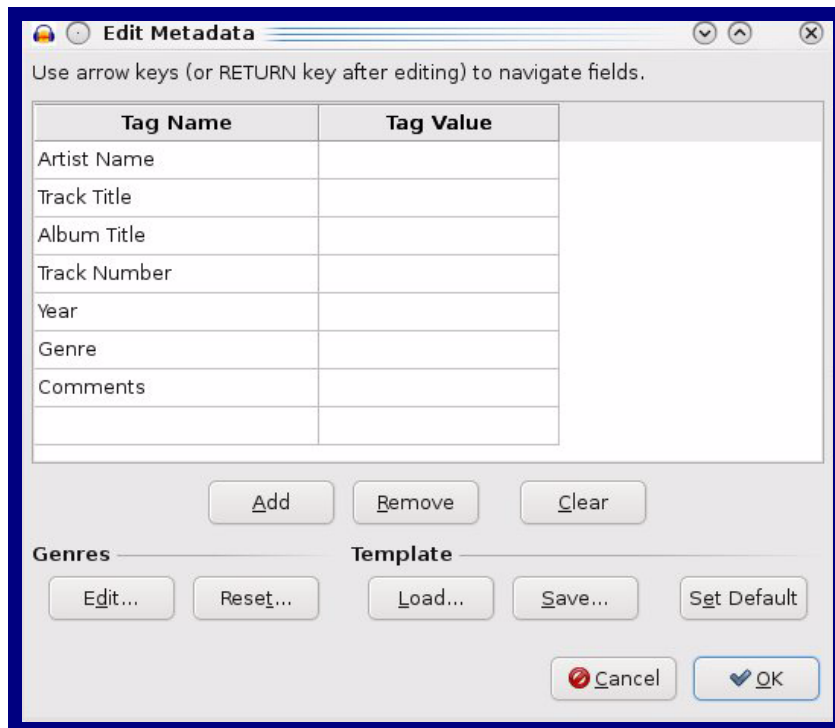

Figure 2-26. Audacity 2



When you export an audio file with Audacity, save the output as:

- WAV (Microsoft) signed 16 bit PCM.

Figure 2-27. WAV (Microsoft) signed 16 bit PCM

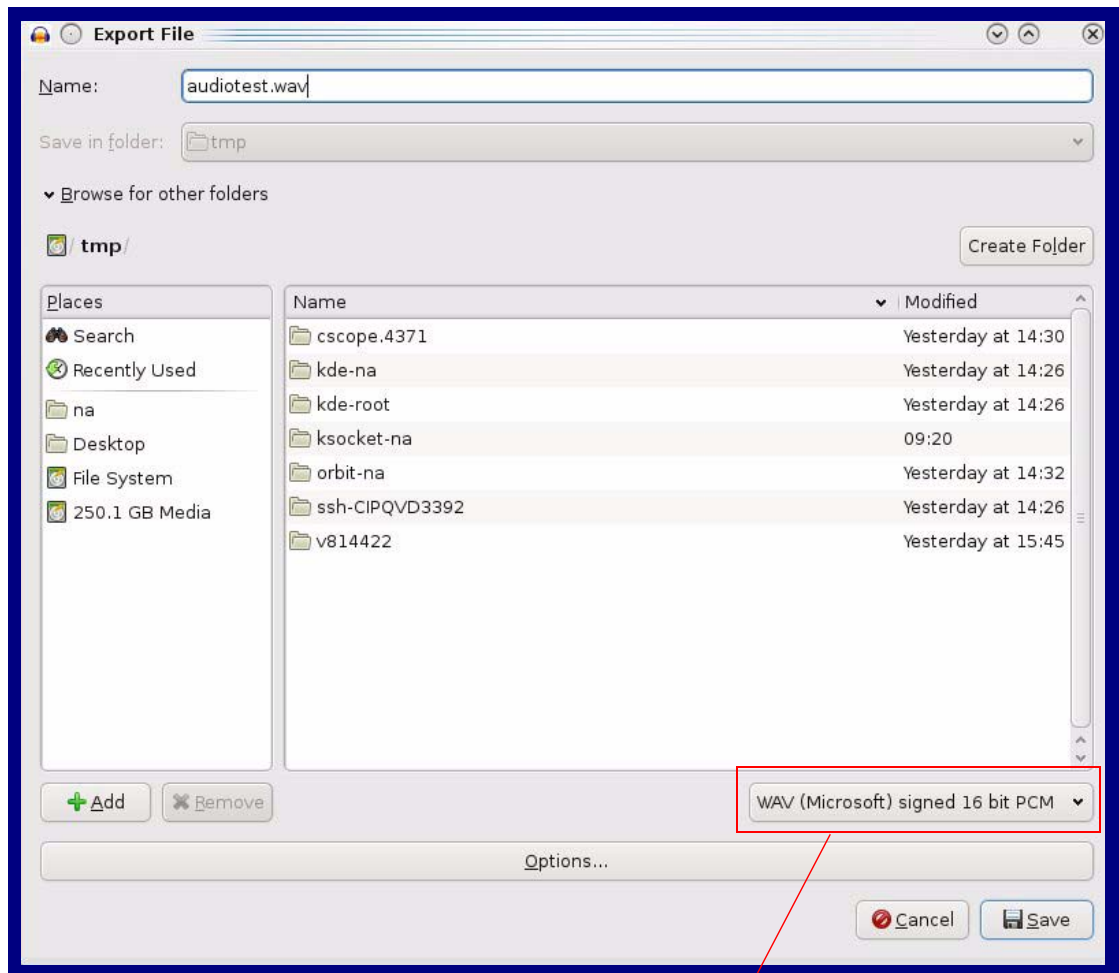

WAV (Microsoft) signed 16 bit PCM

2.3.11 Configure the Event Parameters

Click the **Event Config** button to open the **Event Configuration** page (Figure 2-28). The **Event Configuration** page specifies a remote server that can be used to receive HTTP POST events when actions take place on the board.

Figure 2-28. Event Configuration Page

CyberData Paging Amplifier

Event Configuration

Enable Event Generation:

Remote Event Server

Remote Event Server IP: 10.0.0.254

Remote Event Server Port: 8080

Remote Event Server URL: xmlparse_engine

Events

Enable Call Active Events:

Enable Call Terminated Events:

Enable Relay Activated Events:

Enable Relay Deactivated Events:

Enable Ring Events:

Enable Night Ring Events:

Enable Multicast Start Events:

Enable Multicast Stop Events:

Enable Power on Events:

Enable 60 second Heartbeat Events:

* You need to reboot for changes to take effect

Save Test Event Reboot

Table 2-18 shows the web page items on the **Event Configuration** page.

Table 2-18. Event Configuration

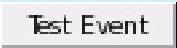
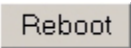
| Web Page Item | Description |
|---|--|
| Enable Event Generation | When selected, Event Generation is enabled. |
| Remote Event Server | |
| Remote Event Server IP | Type the Remote Event Server IP address. (64 character limit) |
| Remote Event Server Port | Type the Remote Event Server port number. (0 - 65535) |
| Remote Event Server URL | Type the Remote Event Server URL. (127 character limit) |
| Events | |
| Enable Call Active Events | When selected, Call Active Events are enabled. |
| Enable Call Terminated Events | When selected, Call Terminated Events are enabled. |
| Enable Relay Activated Events | When selected, Relay Activated Events are enabled. |
| Enable Relay Deactivated Events | When selected, Relay Deactivated Events are enabled. |
| Enable Ring Events | When selected, Ring Events are enabled. |
| Enable Night Ring Events | When selected, there is a notification when the device receives a night ring. |
| Enable Multicast Start Events | When selected, Multicast Start Events are enabled. |
| Enable Multicast Stop Events | When selected, Multicast Stop Events are enabled. |
| Enable Power On Events | When selected, Power On Events are enabled. |
| Enable 60 Second Heartbeat Events | When selected, 60 Second Heartbeat Events are enabled. |
|  | Click the Save button to save your configuration settings. Note: You need to reboot for changes to take effect. |
|  | Click on the Test Event button to test an event. |
|  | Click on the Reboot button to reboot the system. |

2.3.11.1 Example Packets for Events

The server and port are used to point to the listening server and the 'Remote Event Server URL' is the destination URL (typically the script running on the remote server that's used to parse and process the POST events).

Note The XML is URL-encoded before transmission so the following examples are not completely accurate.

Here are example packets for every event:

```
POST xmlparse_engine HTTP/1.1
Host: 10.0.3.79
User-Agent: CyberData/1.0.0
Content-Length: 197
Content-Type: application/x-www-form-urlencoded

<?xml version="1.0" encoding="ISO-8859-1"?>
<cyberdata NAME='CyberData VoIP Device' MAC='0020f70015b6'>
<event>POWERON</event>
</cyberdata>
```

```
POST xmlparse_engine HTTP/1.1
Host: 10.0.3.79
User-Agent: CyberData/1.0.0
Content-Length: 199
Content-Type: application/x-www-form-urlencoded

<?xml version="1.0" encoding="ISO-8859-1"?>
<cyberdata NAME='CyberData VoIP Device' MAC='0020f70015b6'>
<event>HEARTBEAT</event>
</cyberdata>
```

```
POST xmlparse_engine HTTP/1.1
Host: 10.0.3.79
User-Agent: CyberData/1.0.0
Content-Length: 196
Content-Type: application/x-www-form-urlencoded

<?xml version="1.0" encoding="ISO-8859-1"?>
<cyberdata NAME='CyberData VoIP Device' MAC='0020f70015b6'>
<event>BUTTON</event>
</cyberdata>
```

```
POST xmlparse_engine HTTP/1.1
Host: 10.0.3.79
User-Agent: CyberData/1.0.0
Content-Length: 201
Content-Type: application/x-www-form-urlencoded

<?xml version="1.0" encoding="ISO-8859-1"?>
<cyberdata NAME='CyberData VoIP Device' MAC='0020f70015b6'>
<event>CALL_ACTIVE</event>
</cyberdata>
POST xmlparse_engine HTTP/1.1
Host: 10.0.3.79
```

```
User-Agent: CyberData/1.0.0
Content-Length: 205
Content-Type: application/x-www-form-urlencoded

<?xml version="1.0" encoding="ISO-8859-1"?>
<cyberdata NAME='CyberData VoIP Device' MAC='0020f70015b6'>
<event>CALL_TERMINATED</event>
</cyberdata>

POST xmlparse_engine HTTP/1.1
Host: 10.0.3.79
User-Agent: CyberData/1.0.0
Content-Length: 197
Content-Type: application/x-www-form-urlencoded

<?xml version="1.0" encoding="ISO-8859-1"?>
<cyberdata NAME='CyberData VoIP Device' MAC='0020f70015b6'>
<event>RINGING</event>
</cyberdata>

POST xmlparse_engine HTTP/1.1
Host: 10.0.3.79
User-Agent: CyberData/1.0.0
Content-Length: 234
Content-Type: application/x-www-form-urlencoded

<?xml version="1.0" encoding="ISO-8859-1"?>
<cyberdata NAME='CyberData VoIP Device' MAC='0020f70015b6'>
<event>MULTICAST_START</event>
<index>8</index>
</cyberdata>

POST xmlparse_engine HTTP/1.1
Host: 10.0.3.79
User-Agent: CyberData/1.0.0
Content-Length: 233
Content-Type: application/x-www-form-urlencoded

<?xml version="1.0" encoding="ISO-8859-1"?>
<cyberdata NAME='CyberData VoIP Device' MAC='0020f70015b6'>
<event>MULTICAST_STOP</event>
<index>8</index>
</cyberdata>

POST xmlparse_engine HTTP/1.1
Host: 10.0.3.79
User-Agent: CyberData/1.0.0
Content-Length: 234
Content-Type: application/x-www-form-urlencoded
<?xml version="1.0" encoding="ISO-8859-1"?>
<cyberdata NAME='CyberData VoIP Device' MAC='0020f70015b6'>
<event>RELAY_ACTIVATED</event>
</cyberdata>
POST xmlparse_engine HTTP/1.1
Host: 10.0.3.79
```

```
User-Agent: CyberData/1.0.0
Content-Length: 234
Content-Type: application/x-www-form-urlencoded
<?xml version="1.0" encoding="ISO-8859-1"?>
<cyberdata NAME='CyberData VoIP Device' MAC='0020f70015b6'>
<event>RELAY_DEACTIVATED</event>
</cyberdata>
```

```
POST xmlparse_engine HTTP/1.1
Host: 10.0.3.79
User-Agent: CyberData/1.0.0
Content-Length: 234
Content-Type: application/x-www-form-urlencoded
<?xml version="1.0" encoding="ISO-8859-1"?>
<cyberdata NAME='CyberData VoIP Device' MAC='0020f70015b6'>
<event>NIGHTRINGING</event>
</cyberdata>
```

2.3.12 Configure the Autoprovisioning Parameters

1. Click the **Autoprovisioning** button to open the **Autoprovisioning Configuration** page.
See [Figure 2-17](#).

Figure 2-29. Autoprovisioning Configuration Page

The screenshot shows the 'Autoprovisioning' configuration page for the CyberData Paging Amplifier. The page has a blue header with the title 'CyberData Paging Amplifier'. On the left side, there is a vertical menu with buttons for 'Home', 'Device Config', 'Networking', 'SIP Config', 'Nightringer', 'Sensor Config', 'Multicast Config', 'Audio Config', 'Event Config', 'Autoprovisioning', and 'Update Firmware'. The 'Autoprovisioning' button is highlighted. The main content area is titled 'Autoprovisioning' and contains the following settings:

- Enable Autoprovisioning:
- Get Autoprovisioning from DHCP:
- Autoprovisioning Server (IP Address):
- Autoprovisioning autoupdate (in minutes):

Below the settings, there are two asterisked notes:

- * Autoprovisioning file name: 0020f7006207.config
- * You need to reboot for changes to take effect

At the bottom of the configuration area, there are two buttons: 'Save' and 'Reboot'.

2. On the **Autoprovisioning Configuration** page, you may enter values for the parameters indicated in [Table 2-11](#).

Table 2-19. Autoprovisioning Configuration Parameters

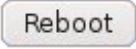
| Web Page Item | Description |
|---|--|
| Autoprovisioning | |
| Enable Autoprovisioning | See Section 2.3.12.1, "Autoprovisioning" . |
| Get Autoprovisioning from DHCP | See Section 2.3.12.1, "Autoprovisioning" . |
| Autoprovisioning Server (IP Address) | See Section 2.3.12.1, "Autoprovisioning" (15 character limit). |
| Autoprovisioning Autoupdate (in minutes) | Type the desired time (in minutes) that you want the Autoprovisioning feature to update (6 character limit). |
|  | Click the Save button to save your configuration settings. Note: You need to reboot for changes to take effect. |
|  | Click on the Reboot button to reboot the system. |

3. After changing the parameters, click the **Save** button.

2.3.12.1 Autoprovisioning

Enable Autoprovisioning Option With autoprovisioning enabled, the board will get its configuration from a remote TFTP server on startup or periodically on a scheduled delay. Autoprovisioned values will override values stored in on-board memory and will be visible on the web page. The board gets its autoprovisioning information from an XML-formatted file hosted from a TFTP server. CyberData will provide a template for this XML file and the user can modify it for their own use.

To use autoprovisioning, create a copy of the autoprovisioning template with the desired settings and name this file with the mac address of the device to configure (for example: **0020f7350058.config**). Put this file into your TFTP server directory and manually set the TFTP server address on the board.

It is not necessary to set every option found in the autoprovisioning template. As long as the XML is valid, the file can contain any subset. Options not autoprovisioned will default to the values stored in the on board memory. For example if you only wanted to modify the device name, the following would be a valid autoprovisioning file:

```
<?xml version="1.0" encoding="utf-8" ?>
<specific>
  <MiscSettings>
    <DeviceName>auto V2 Paging Amplifier</DeviceName>
  </MiscSettings>
</specific>
```

Networking The board will only apply networking settings or firmware upgrades after a reboot.

Get Autoprovisioning from DHCP When this option is checked, the device will automatically fetch its autoprovisioning server address from the DHCP server. The device will use the address specified in **OPTION 150** (TFTP-server-name) or **OPTION 66**. If both options are set, the device will use **OPTION 150**.

Refer to the documentation of your DHCP server for setting up **OPTION 150**.

To set up a Linux DHCPD server to serve autoprovisioning information (in this case using both option 66 and 150), here's an example dhcpd.conf:

```
# dhcpd.conf
#
# Configuration file for ISC dhcpd (see 'man dhcpd.conf')
#
ddns-update-style ad-hoc;

option option-150 code 150 = ip-address;

subnet 10.0.0.0 netmask 255.0.0.0 {
    max-lease-time 120;
    default-lease-time 120;

    option routers                10.0.0.1;
    option subnet-mask            255.0.0.0;

    option domain-name            "voiplab";
    option domain-name-servers    10.0.0.1;

    option time-offset            -8;      # Pacific Standard Time

    option tftp-server-name       "10.0.0.254";

    option option-150             10.0.0.254;

    range 10.10.0.1 10.10.2.1;}
```

Autoprovisioning Server (IP Address) Instead of using DHCP to provide the autoprovisioning tftp server address, you can specify an address manually.

Autoprovisioning Autoupdate If **Autoprovisioning** is enabled and the **Autoprovisioning Autoupdate** value is something other than 0 minutes, a service is started on startup that will wait the configured number of minutes and then try to re-download its autoprovisioning file. It will compare its previously autoprovisioned file with this new file and if there are differences, it will reboot the board.

Autoprovisioned Firmware Upgrades An Autoprovisioned firmware upgrade only happens after a reboot, will take roughly three minutes, and the web page will be unresponsive during this time.

The '**FirmwareVersion**' value in the xml file *must* match the version stored in the '**FirmwareFile**'.

```
<FirmwareVersion>v5.0.5b01</FirmwareVersion>
<FirmwareFile>505b01-uImage-ceilingsspeak</FirmwareFile>
```

If these values are mismatched, the board can get stuck in a loop where it goes through the following sequence of actions:

1. The board downloads and writes a new firmware file.
2. After the next reboot, the board recognizes that the firmware version does not match.
3. The board downloads and writes the firmware file again.

CyberData has timed a firmware upgrade at 140 seconds. Therefore, if you suspect the board is stuck in a loop, either remove or comment out the **FirmwareVersion** line in the XML file and let the board boot as it normally does.

Autoprovisioned
Audio Files

Audio files are stored in non-volatile memory and an autoprovisioned audio file will only have to be downloaded once for each device. Loading many audio files to the device from the web page could cause it to appear unresponsive. If this happens, wait until the transfer is complete and then refresh the page.

The device uses the file name to determine when to download a new audio file. This means that if you used autoprovisioning to upload a file and then changed the contents of this file at the TFTP server, the device will not recognize that the file has changed (because the file name is the same).

Since audio files are stored in non-volatile memory, if autoprovisioning is disabled after they have been loaded to the board, the audio file settings will not change. You can force a change to the audio files on the board by clicking **Restore Default** on the **Audio Configuration** page or by changing the autoprovisioning file with **"default"** set as the file name.

2.3.13 Upgrade the Firmware and Reboot the Paging Amplifier

To upload the Paging Amplifier firmware from your PC:

1. Set up a TFTP server.
If you do not already have a TFTP server running on your network, see [Appendix B, "Setting up a TFTP Server"](#).
2. Retrieve the latest Paging Amplifier firmware from the VoIP V2 Paging Amplifier **Downloads** page at:
<http://www.cyberdata.net/products/voip/digitalanalog/pagingampv2/downloads.html>
3. Unzip the Paging Amplifier version file. This file may contain the following:
 - Firmware file
 - Release notes
4. Copy the firmware files to be upgraded to the appropriate TFTP server directory:
 - c:\tftp-root\for Windows
 - /tftpboot/for Linux
5. Log in to the Paging Amplifier home page as instructed in [Section 2.3.2, "Log in to the Configuration Home Page"](#).

6. Click the **Update Firmware** button to open the **Upgrade Firmware** page. See [Figure 2-30](#).

Figure 2-30. Firmware Upgrade Page

The screenshot shows the 'Upgrade Firmware' page of the CyberData Paging Amplifier. The page features a blue header with the title 'CyberData Paging Amplifier'. On the left side, there is a vertical navigation menu with buttons for 'Home', 'Device Config', 'Networking', 'SIP Config', 'Nightringer', 'Sensor Config', 'Multicast Config', 'Audio Config', 'Event Config', 'Autoprovisioning', and 'Update Firmware'. The main content area is titled 'Upgrade Firmware' and displays the current 'Firmware Version: v1.1.1-beta1'. Below this, there are two input fields: 'TFTP Server IP:' with the value '10.0.0.254' and 'New Filename:' which is currently empty. A note below the fields states 'System will automatically reboot after upgrading firmware'. At the bottom of the form, there are 'Submit' and 'Reboot' buttons.

7. Enter the IP address of your TFTP server into the **TFTP Server IP** parameter field.
8. Enter the firmware filename of the file to be uploaded into the **New Filename** parameter field.
For example, kernel filename **100-uImage-pagingamp.bin**.
9. Click **Upload File**.

Note This starts the upload process. Once the Paging Amplifier has uploaded the file, the **Uploading Firmware** countdown page appears, indicating that the firmware is being written to flash. The Paging Amplifier will automatically reboot when the upload is complete. When the countdown finishes, the **Upgrade Firmware** page will refresh. The uploaded firmware filename should be displayed in the system configuration (indicating successful upload and reboot).

Table 2-20 shows the web page items on the **Upgrade Firmware** page.

Table 2-20. Firmware Upgrade Parameters

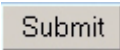
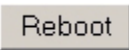
| Web Page Item | Description |
|---|---|
| Firmware Version | Shows the current firmware version. |
| TFTP Server IP address | Enter the IP address of your TFTP server into the TFTP Server IP parameter field (15 character limit). |
| New Filename | Use this field to enter the new file name for the firmware file that you are uploading (25 character limit). |
|  | Click on the Submit button to automatically upload the selected firmware and reboot the system. |
|  | Click on the Reboot button to reboot the system. |

2.3.14 Reboot the Paging Amplifier

To reboot a Paging Amplifier, log in to the web page as instructed in [Section 2.3.2, "Log in to the Configuration Home Page"](#).

1. Click **Update Firmware** to open the **Upgrade Firmware** page ([Figure 2-31](#)).

Figure 2-31. Reboot System Section

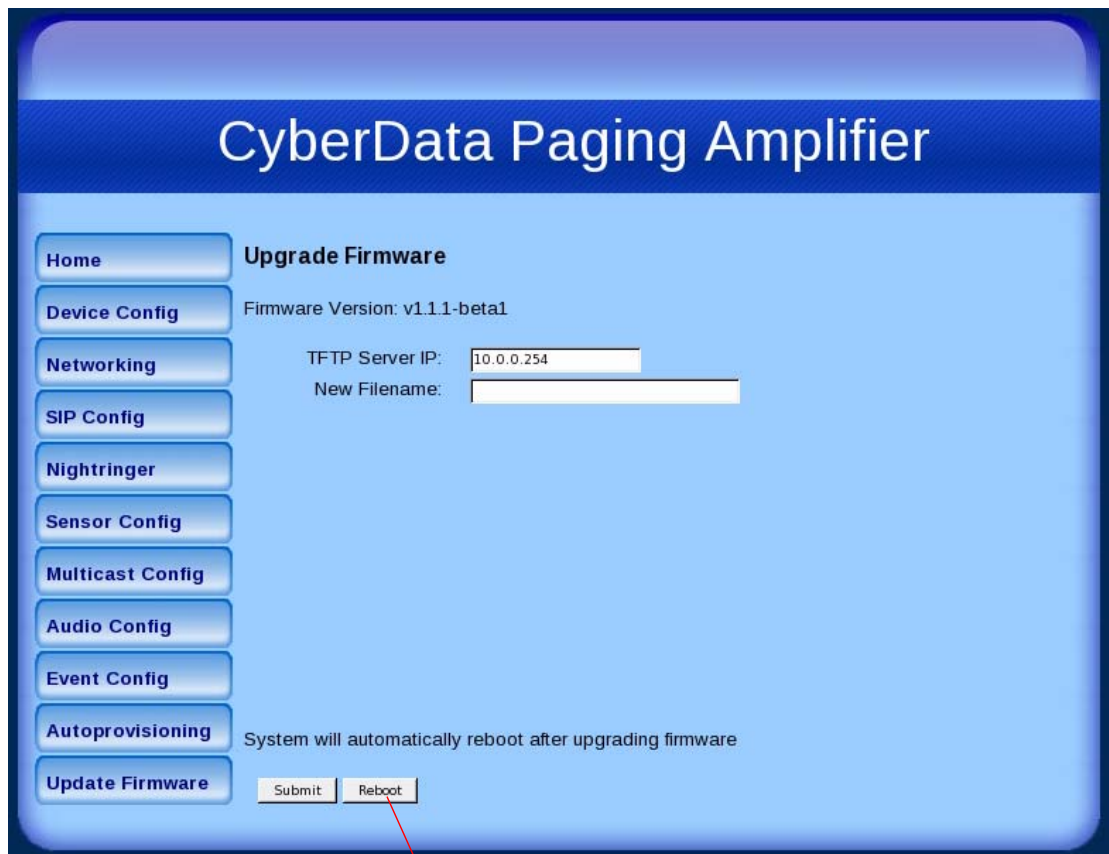

Reboot

2. Click **Reboot**. A normal restart will occur and you will see the following Reboot page.

Figure 2-32. Reboot Page





Appendix A: Mounting the Amplifier

A.1 Mount the Amplifier

Before you mount the enclosure, make sure that you have received all of the parts for each enclosure. Refer to [Table A-21](#).

Table A-21. Wall Mounting Components (Part of the Accessory Kit)

| Quantity | Part Name | Illustration |
|----------|------------------------|---|
| 2 | Plastic Ribbed Anchors |  |
| 2 | #6 Sheet Metal Screws |  |

Note The V2 Paging Amplifier was designed for indoor use. Mounting it on the external part of a building will require additional hardware for weatherproofing, cabling access, and lightning suppression. Consult a certified electrician for details.

Note For mounting, use the two **#6 SHEET METAL SCREWS** to secure the enclosure.

Appendix B: Setting up a TFTP Server

B.1 Set up a TFTP Server

Upgrading the VoIP V2 Paging Amplifier firmware requires a TFTP server on which you access the Web interface where you can upload the firmware files.

B.1.1 In a LINUX Environment

To set up a TFTP server on LINUX:

1. Create a directory dedicated to the TFTP server, and move the files to be uploaded to that directory.
2. Run the following command where `/tftpboot/` is the path to the directory you created in [Step 1](#): the directory that contains the files to be uploaded. For example:

```
in.tftpd -l -s /tftpboot/your_directory_name
```

B.1.2 In a Windows Environment

You can find several options online for setting up a Windows TFTP server. This example explains how to use the Solarwinds freeware TFTP server, which you can download at:

<http://www.cyberdata.net/support/voip/solarwinds.html>

To set up a TFTP server on Windows:

1. Install and start the software.
2. Select **File/Configure/Security** tab/**Transmit Only**.
3. Make a note of the default directory name, and then move the firmware files to be uploaded to that directory.

Appendix C: Troubleshooting/Technical Support

C.1 Frequently Asked Questions (FAQ)

To see a list of frequently asked questions for your product, do the following:

1. Go to the following URL:

<http://www.cyberdata.net/products/voip/digitalanalog/pagingampv2/faqs.html>

2. Go to the support page for your product, and click on the **FAQs** tab.

C.2 Documentation

The documentation for this product is released in an English language version only. You can download PDF copies of CyberData product documentation by doing the following:

1. Go to the following URL:

<http://www.cyberdata.net/products/voip/digitalanalog/pagingampv2/docs.html>

2. Go to the support page for your product, and click on the **Documentation** tab.

C.3 Contact Information

| | |
|----------------------------------|---|
| Contact | <p>CyberData Corporation 2555 Garden Road Monterey, CA 93940 USA www.CyberData.net Phone: 800-CYBERDATA (800-292-3732) Fax: 831-373-4193</p> |
| Sales | Sales 831-373-2601 Extension 334 |
| Technical Support | <p>Phone: 831-373-2601 Extension 333 Web: http://www.cyberdata.net/support/contactsupportvoip.html</p> |
| Returned Materials Authorization | <p>To return the product, contact the CyberData Returned Materials Authorization (RMA) department at:</p> <p>Phone: 831-373-2601, Extension 136 Email: RMA@CyberData.net</p> <p>When returning a product to CyberData, an approved CyberData RMA number must be printed on the outside of the original shipping package. No product will be accepted for return without an approved RMA number. Send the product, in its original package, to the following address:</p> <p>CyberData Corporation 2555 Garden Road Monterey, CA 93940 Attention: RMA "your RMA number"</p> |
| RMA Status Form | <p>If you need to inquire about the repair status of your product(s), please use the CyberData RMA Status form at the following web address:</p> <p>http://www.cyberdata.net/support/rmastatus.html</p> |

C.4 Warranty

CyberData warrants its product against defects in material or workmanship for a period of two years from the date of purchase. Should the product fail within the warranty period, CyberData will repair or replace the product free of charge. This warranty includes all parts and labor.

Should the product fail out-of-warranty, a flat rate repair charge of one half of the purchase price of the product will be assessed. Repairs that are in warranty but are damaged by improper modifications or abuse, will be charged at the out-of-warranty rate. Products shipped to CyberData, both in and out-of-warranty, are shipped at the expense of the customer. Shipping charges for repaired products shipped back to the customer by CyberData, will be paid by CyberData.

CyberData shall not under any circumstances be liable to any person for any special, incidental, indirect or consequential damages, including without limitation, damages resulting from use or malfunction of the products, loss of profits or revenues or costs of replacement goods, even if CyberData is informed in advance of the possibility of such damages.

C.4.1 Warranty & RMA Returns within the United States

If service is required, you must contact CyberData Technical Support prior to returning any products to CyberData. Our Technical Support staff will determine if your product should be returned to us for further inspection. If Technical Support determines that your product needs to be returned to CyberData, an RMA number will be issued to you at this point.

Your issued RMA number must be printed on the outside of the shipping box. No product will be accepted for return without an approved RMA number. The product in its original package should be sent to the following address:

CyberData Corporation

2555 Garden Rd.

Monterey, CA 93940

Attn: RMA "xxxxxx"

C.4.2 Warranty & RMA Returns Outside of the United States

If you purchased your equipment through an authorized international distributor or reseller, please contact them directly for product repairs.

C.4.3 Spare in the Air Policy

CyberData now offers a *Spare in the Air* no wait policy for warranty returns within the United States and Canada. More information about the *Spare in the Air* policy is available at the following web address:

<http://www.cyberdata.net/support/warranty/spareintheair.html>

C.4.4 Return and Restocking Policy

For our authorized distributors and resellers, please refer to your CyberData Service Agreement for information on our return guidelines and procedures.

For End Users, please contact the company that you purchased your equipment from for their return policy.

C.4.5 Warranty and RMA Returns Page

The most recent warranty and RMA information is available at the CyberData Warranty and RMA Returns Page at the following web address:

<http://www.cyberdata.net/support/warranty/index.html>

Index

Symbols

#6 sheet metal screws 55

A

accessory kit 5
 activate relay (door sensor) 31
 activity LED 12
 address, configuration login 17
 announcing an IP address 13
 audio (buffered) 35
 audio configuration 36
 night ring tone parameter 37
 audio configuration page 36
 audio encodings 3
 autoprovisioning 46, 48
 autoprovisioned audio files 50
 autoprovisioned firmware upgrades 49
 autoprovisioning autoupdate 49
 autoprovisioning enabled option 48
 autoprovisioning from DHCP 48
 autoprovisioning server (IP address) 49
 networking 48
 autoprovisioning configuration 47

B

buffered audio 35

C

cabling 11
 configurable parameters 19, 21
 configuration
 default IP settings 15
 door sensor 30
 intrusion sensor 30
 network 23
 SIP 25
 using Web interface 15
 configuration home page 18
 configuration page
 configurable parameters 19, 21
 contact information 58
 contact information for CyberData 58

Current Network Settings 24
 current network settings 24
 CyberData contact information 58

D

default
 gateway 6, 15
 IP address 6, 15
 subnet mask 6, 15
 username and password 6, 15
 web login username and password 18
 default gateway 6, 15, 24
 default IP settings 15
 default login address 17
 device configuration
 device configuration parameters 47
 the device configuration page 46
 device configuration page 20
 device configuration parameters 21
 DHCP Client 3
 DHCP IP addressing 24
 dial out extension (door sensor) 31
 discovery utility program 17
 DNS server 24
 door sensor 30, 37
 activate relay 31
 dial out extension 31
 play audio locally 31
 play audio remotely 31

E

enable night ring events 42
 enclosure, mounting 55
 event configuration
 enable night ring events 42
 expiration time for SIP server lease 26, 29

F

factory defaults 7, 13
 firmware
 where to get the latest firmware 51
 firmware upgrade parameters 53
 firmware upgrades 56

H

hazard levels 5
 home page 18
 http web-based configuration 3

I

identifying your product 1
 illustration of amplifier mounting process 55
 installation 2
 IP address 6, 15, 24, 38, 53
 IP addressing 24
 default
 IP addressing setting 6, 15

L

lease, SIP server expiration time 26, 29
 LEDs 12
 lengthy pages 35
 link LED 12
 Linux, setting up a TFTP server on 56
 local SIP port 26
 log in address 17
 loudspeaker, cabling/wiring 11
 loudspeaker, type 11

M

MGROUP
 MGROUP Name 34
 mounting an amplifier 55
 multicast configuration 32
 Multicast IP Address 34

N

navigation (web page) 16
 navigation table 16
 network configuration of intercom 23
 network link activity, verifying 12
 Network Setup 23
 nightring tones 35
 Nightringer 28
 nightringer settings 29

O

outbound proxy 26

P

packet time 3
 pages (lengthy) 35
 parts list 5
 password
 for SIP server login 26
 login 18
 restoring the default 6, 15
 play audio locally (door sensor) 31
 play audio remotely (door sensor) 31
 point-to-point configuration 27
 port
 local SIP 26
 remote SIP 26
 power LED 12
 priority
 assigning 35
 product
 configuring 15
 mounting 55
 parts list 5
 product features 2
 product overview
 product features 2
 product specifications 4
 supported protocols 3
 supported SIP servers 3
 typical system installation 2
 product specifications 4
 protocols supported 3

R

reboot 53, 54
 registration and expiration, SIP server lease 26
 remote SIP port 26
 reset test function management switch 13
 resetting the IP address to the default 55
 restoring the factory defaults 7, 13
 return and restocking policy 59
 ringtones 35
 lengthy pages 35
 RMA returned materials authorization 58
 RMA status 58
 RTFM switch 7, 13
 RTP port 26
 RTP/AVP 3

S

- safety instructions 4
- sales 58
- sensor
 - sensor normally closed 31
- sensor settings 31
- sensor setup page 30
- sensor setup parameters 30
- server address, SIP 26
- service 58
- setting up a TFTP server 56
- SIP
 - enable SIP operation 25
 - local SIP port 26
 - user ID 26
- SIP (session initiation protocol) 3
- SIP configuration 25
 - SIP Server 26
- SIP configuration parameters
 - registration and expiration, SIP server lease 29
- SIP registration 26
- SIP remote SIP port 26
- SIP server 26
 - password for login 26
 - SIP servers supported 3
 - unregister from 26
 - user ID for login 26
- SIP settings 26
- Spare in the Air Policy 59
- speaker cable 11
- speaker wire 11
- static IP addressing 24
- status LED 12
- subnet mask 6, 15, 24
- supported protocols 3

T

- tech support 58
- technical support, contact information 58
- test audio button 22, 38
- TFTP server 3, 56

U

- user ID
 - for SIP server login 26
- user ID, SIP 26
- username
 - default for web configuration access 18
 - restoring the default 6, 15

V

- verifying
 - network link and activity 12
 - power on 12
- volume 14
- volume dial 14

W

- warranty 58
- warranty & RMA returns outside of the United States 59
- warranty & RMA returns within the United States 59
- warranty and RMA returns page 59
- warranty policy at CyberData 58
- web access password 6, 15
- web access username 6, 15
- web configuration log in address 17
- web page
 - navigation 16
- web page navigation 16
- web-based paging amplifier configuration 15
- Windows, setting up a TFTP server on 56
- wiring 11